

# MIPRO<sup>®</sup>

## User Guide

### ACT-30TC/ACT-32TC/ACT-52TC Rechargeable Bodypack Transmitter



**MIPRO<sup>®</sup>**  
MICROPHONE PROFESSIONALS

**MIPRO Electronics Co., Ltd**

Headquarters : 814 Pei-Kang Road, Chiayi, 60096, Taiwan  
Tel : +886.5.238.0809 Fax : +886.5.238.0803  
www.mipro.com.tw mipro@mipro.com.tw



2 CE512 B

All rights reserved. MN 016/02

Do not copy or forward without prior approvals MIPRO.

Specifications and design subject to change without notice.

## Contents

- 1 Bodypack Controls and Indicators
- 3 Operating Instructions
- 4 LCD Display Screen
- 5 Transmitter Parameters
- 10 Battery Status
- 12 MUTE Mode Setting
- 14 AF Input Connections
- 15 Battery Removal and Installation

## Bodypack Controls and Indicators

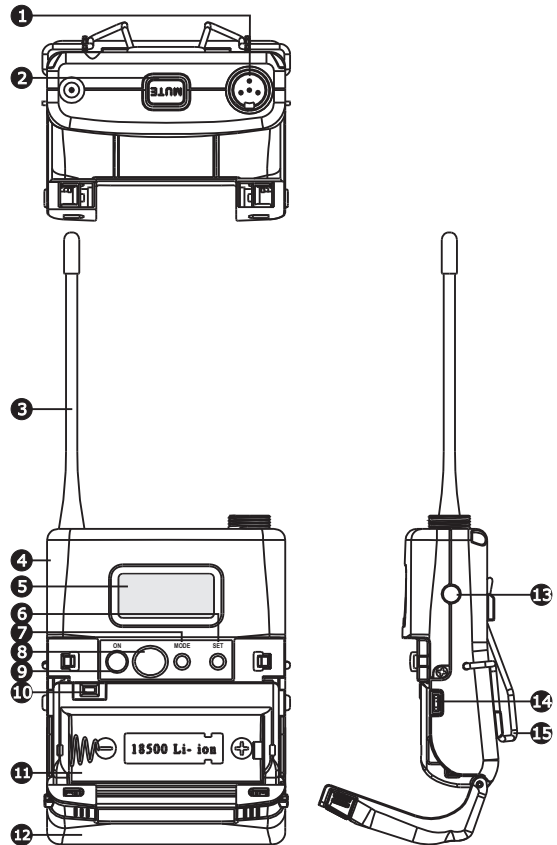

- 1 Audio Input Connector:** TA4F mini 4-pin connector accepts any MIPRO lavalier, instrument and headset microphones and cables. (See 5 ways of connection on AF Input Connections)

- 2 **MUTE Button:** To mute and un-mute the audio signal temporary.
- 3 **Antenna:** Flexible 1/ 4 wave transmitting antenna.
- 4 **Transmitter Housing:** Holds PCB board and wires.
- 5 **LCD Panel:** Display transmitter parameters.
- 6 **SET Button:** Parameter selection button.
- 7 **MODE Button:** Allows access to available functions displaying in LCD panel.
- 8 **ACT IR Port:** Align and syncs the transmitter and receiver frequency automatically.
- 9 **Power Button:** Press and hold 2 seconds to power ON or OFF.
- 10 **Battery Circuitry Protection Reset Button**
- 11 **Battery Compartment:** Accommodates one 18500 rechargeable battery.
- 12 **Battery Cover:** Hinged cover opens to provide access to one 18500 rechargeable battery.
- 13 **External Mute Connector:** When an external mute switch cable, MJ-70 (optional) is connected , user can manually mute and un-mute the audio temporary.
- 14 **Battery Charging Contact:** Align contacts during charging.
- 15 **Belt Clip:** Detachable and reversible design allows the transmitter to be worn on a belt, waistband, or guitar strap (Figure 1).

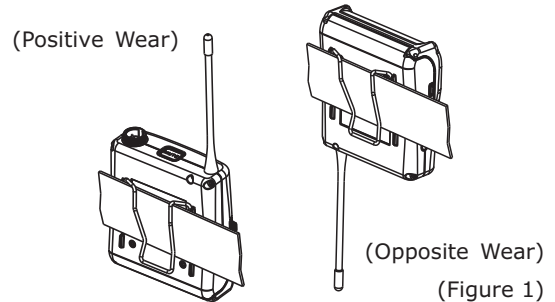

## Operating Instructions

- Insert the lavalier, headset microphone or instrument cable into the audio input connector before power ON the transmitter.
- Tighten the connector screw clockwise direction as shown in (Figure 2) for a secured fit.

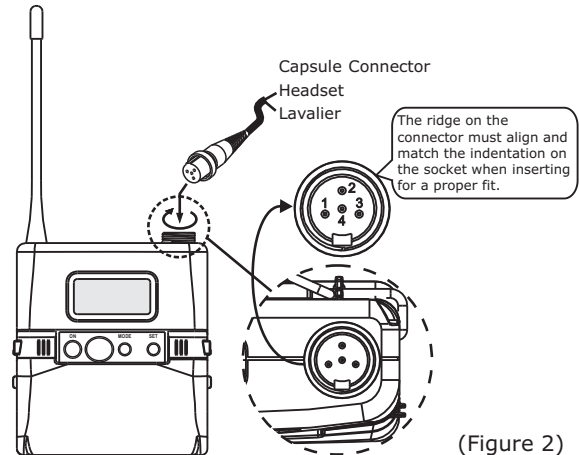

## LCD Display Screen



- A1 LCD Screen for Function Display
- A2 Parameters Screen
- A3 Transmitter Battery Meter

## Transmitter Parameters

- **MODE** button  
Press "**MODE**" button to access one of the functions below.
- **SET** button  
Press "**SET**" button then the changeable functions will twinkle. Change to the desired parameters during the above twinkle by pressing "**SET**" button.

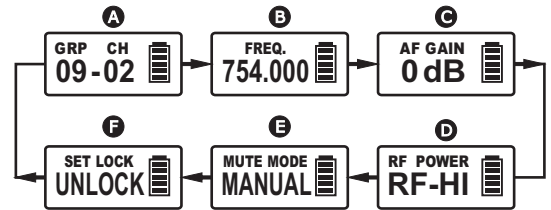
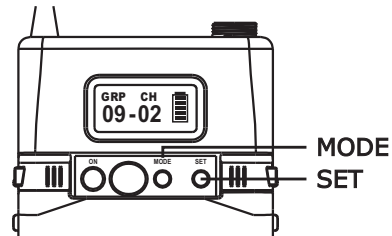

- A Group and Channel
- B Frequency
- C Sensitivity Level
- D RF Output Power
- E MUTE Mode
- F Parameters Lock & Unlock Status

- **Group & Channel** and **Frequency** are factory preset, thus, its parameter values are displayed after it is ACT synced. Values cannot be changed.



## Setting Input Gain Level

- Selectable **AF GAIN** between 12dB to -18dB with 6dB parameter up or down selection.
- Press MODE button until AF GAIN mode appears.
- Press SET button once to activate function.
- Press SET button to select the desired sensitivity level.
- Press MODE button to confirm and save the change.
- The higher the sensitivity level, the lower the dynamic range of input signals. Meanwhile noise will increase, and the feedback problem will be getting more serious.

### NOTE:

- The audio gain level is factory preset at 0dB level.
- Guitar setting is recommended at -12dB level.

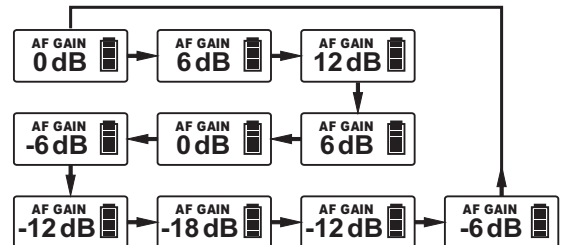

## Setting RF Output Power

- 2 RF Output Power Levels: RF-LOW and RF-HI.
- Press MODE button until **RF POWER** mode appears.
- Press SET button once to activate function.
- Press SET button to select the desired RF output power.
- Press MODE button to confirm and save the change.

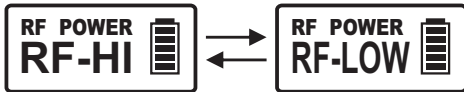

## MUTE MODE

- MUTE MODE: Select from MANUAL and DISABLE.
- Press MODE button until **MUTE MODE** appears. Press SET button once, the LCD screen starts flashing to denote it is ready to accept mode changes. Press SET button to change between MANUAL and DISABLE in cycle. Press MODE button to confirm and save the change, or LCD will stop flashing and parameter will be saved.
- MUTE button is operable when MUTE MODE is set in MANUAL mode.
- MUTE button is not operable when MUTE MODE is set in DISABLE mode.

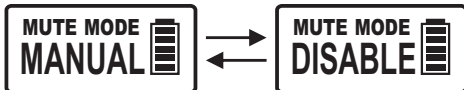

## Setting LOCK

- Setting LOCK can be switched to LOCK or UNLOCK mode.
- Press MODE button until **SET LOCK** mode appears.
- Press SET button to select the desired parameter.
- Press MODE button to confirm and save the change.
- Press SET button twice to remove the LOCK function.
- The LOCK function will be removed automatically when losing power.
- Mute function can still work properly when LOCK.

NOTE: Once locked, all 6 parameter values cannot be changed.

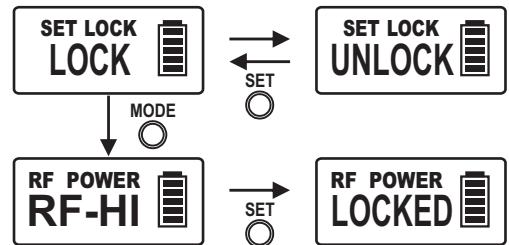

## Battery Status

- Indicates the power remaining in the transmitter battery. When the battery has less than 10% power remaining it must be replaced or recharged. If an under voltage condition continues, the LCD will show "OFF..." and the system will shut down to prevent being overly discharged.

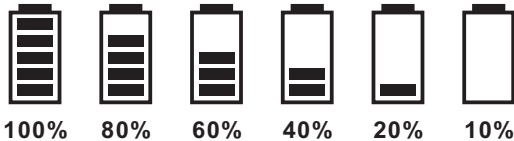

## Power Button

- Press and hold for 2 seconds to power on & off. "OFF..." - Power Off
- When the power switch is turned off, the LCD will show "OFF..." (for Power Off) first and then the system will shut down and no further messages will be displayed.

OFF...

## ERR Message

- When "ERR" appears in the display it indicates that an operational error has occurred. Please refer to the following codes to diagnose which error you are experiencing.
  - ERR no01** EEPROM is not being programmed or internal data error.
  - ERR no02** For testing only.
  - ERR no03** The frequency you want to program is above the switching bandwidth of the transmitter. Use a receiver with an appropriate frequency group. (At this time the microphone is still operating and the frequency remains unchanged. To clear the displayed "ERR" message, switch the handheld transmitter off and on again.)
  - ERR no04** The frequency you want to program is below the switching bandwidth of the transmitter. Use a receiver with an appropriate frequency group. (At this time the microphone is still operating and the frequency remains unchanged. To clear the displayed "ERR" message, switch the handheld transmitter off and on again.)
- "Group" & "Channel":** When both the group and channel numbers are displayed, it means that you are using the pre-programmed frequency of the receiver.
- "Channel" Only:** If "Channel" only is displayed, it means that you are using a frequency which is not pre-programmed.

## MUTE Mode Setting

- Press MUTE button once to MUTE audio.  
"MUTE" appears.
- Press MUTE button again to UNMUTE audio  
"UNMUTE" appears.
- MUTE button is operable when MUTE MODE is set in MANUAL mode.

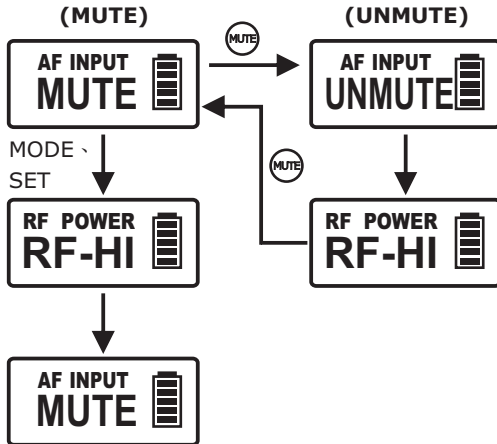
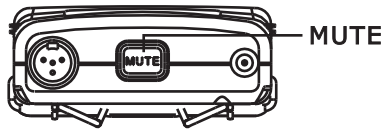

## External Mute Connector

- External mute connector is a 3.5mm jack. When an external mute switch cable, MJ-70 (optional) is connected, user can manually mute and unmute the audio temporary.

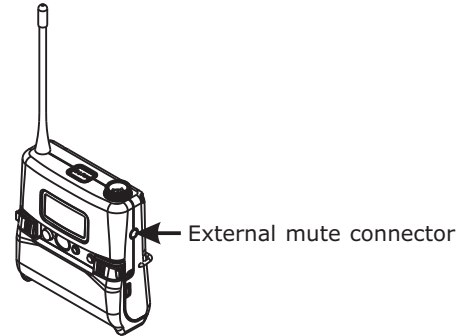

## MJ-70 External Mute Switch (optional)

- Ⓑ1 3.5mm jack.
- Ⓑ2 External mute switch on/off button.

**NOTE:** Plug in the device before power on the bodypack transmitter.

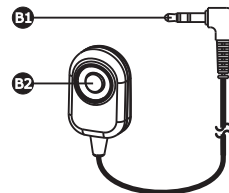



## AF Input Connections

- (1) 2-Wire Electret condenser microphone Capsule



- (2) 3-Wire Electret condenser microphone Capsule

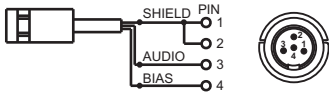

- (3) Dynamic Microphone

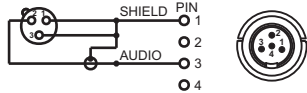

- (4) Electric Guitar

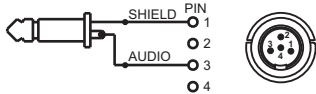

- (5) Line-in (Impedance 8K $\Omega$  ATT. 10dB)

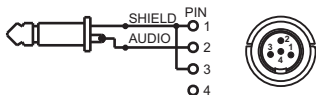

## Battery Removal and Installation

- Pushing down both snap locks on the sides to open battery compartment cover. Take out the two batteries. (Figure 3)
- Insert one charged 18500 rechargeable battery into the battery compartment according to the correct polarity (- and +) as shown in (Figure 4) . Then close the battery compartment cover tightly.

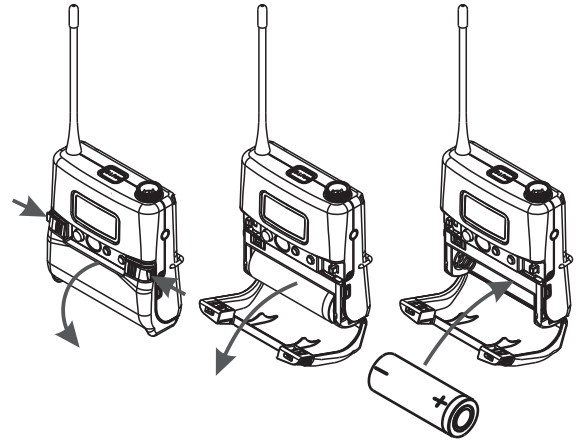

(Figure 3)

(Figure 4)

### Caution

Remove the batteries if unused for a long period of time to prevent battery leakage, corrosion and causes possible damage to electronics.

**Caution**

Note: Transmitter cannot be powered on with charged battery.

Method 1:

- a. Ensure battery is inserted correctly with + top side.
- b. If battery is inserted correctly it could be due to self battery protection mechanism. Insert the transmitter into the charger to re-charge for 10-20 seconds to wake-up the battery. It should work.
- c. If charger cannot be used, reverse the battery insertion for 10-20 seconds, wake up the battery with correct polarity. It should work.

Method 2:

- a. Power off the transmitter before open the hinged cover. Press battery protection circuitry reset button once to wake-up battery. Power on the transmitter.

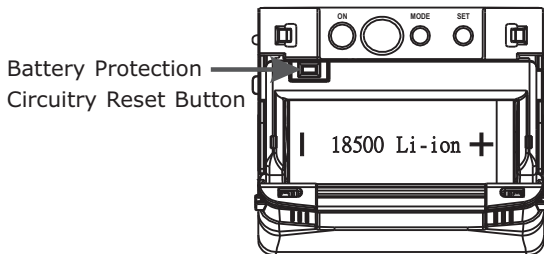
**MP-80 Battery Charger (Optional)**

MP-80 Charger charges both transmitters and 18500 rechargeable batteries.

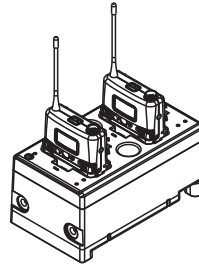

Transmitters Charging

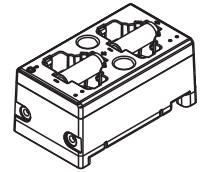

18500 Charging

**MP-20 Dual-Slot Battery Charger** (Optional)

Use the Battery Charger to charge up to two rechargeable 18500 Li-ion batteries for rechargeable MIPRO handheld or bodypack transmitter.

**Charging Batteries:** Insert the batteries with the correct positive (+) & negative (-) polarity and plug the charger into a power outlet, as shown here.

**Charge Status:** The indicator light displays the charging status of the batteries.

- Still Red: The batteries are charging.
- Still Green: The batteries are charged and ready to use.
- Flashing Light: May indicate any of the following conditions:
  - a. The batteries haven't been properly installed in the charger.
  - b. An unsupported type of battery is in the charger.
  - c. The batteries may be faulty or damaged and should be replaced.

Rechargeable 18500 Li-ion  
Batteries

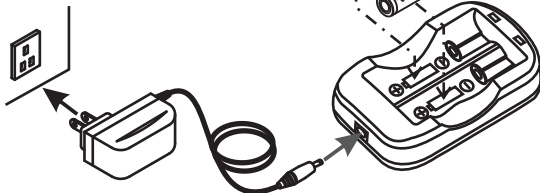

(Transformer is shown here for reference only)

## Notes

1. Refer to actual product in the event of product description discrepancy.
2. Frequency range and maximum deviation comply with the regulations of different countries.

## Federal Communication Commission Interference Statement

This equipment has been tested and found to comply with the limits for a Class B digital device, pursuant to Part 15 of the FCC Rules. These limits are designed to provide reasonable protection against harmful interference in a residential installation. This equipment generates, uses and can radiate radio frequency energy and, if not installed and used in accordance with the instructions, may cause harmful interference to radio communications. However, there is no guarantee that interference will not occur in a particular installation. If this equipment does cause harmful interference to radio or television reception, which can be determined by turning the equipment off and on, the user is encouraged to try to correct the interference by one of the following measures:

- Reorient or relocate the receiving antenna.
- Increase the separation between the equipment and receiver.
- Connect the equipment into an outlet on a circuit different from that to which the receiver is connected.
- Consult the dealer or an experienced radio/TV technician for help.

*FCC Caution:* To assure continued compliance, any changes or modifications not expressly approved by the party responsible for compliance could void the user's authority to operate this equipment. (Example - use only shielded interface cables when connecting to computer or peripheral devices).

### *FCC Radiation Exposure Statement*

This equipment complies with FCC RF radiation exposure limits set forth for an uncontrolled environment. This equipment should be installed and operated with a minimum distance of 0.5 cm between the radiator and your body.

This transmitter must not be co-located or operating in conjunction with any other antenna or transmitter.

The antennas used for this transmitter must be installed to provide a separation distance of at least 0.5 cm from all persons and must not be co-located or operating in conjunction with any other antenna or transmitter.

This device complies with Part 15 of the FCC Rules.

Operation is subject to the following two conditions:

- (1) This device may not cause harmful interference, and
- (2) This device must accept any interference received, including interference that may cause undesired operation.

## IC

This device complies with Industry Canada RSS-210 ISSUE 2 standards. Operation is subject to the following two conditions:

- (1) this device may not cause interference, and
- (2) this device must accept any interference, including interference that may cause undesired operation of the device.

Le présent appareil est conforme aux CNR d'Industrie Canada applicables aux appareils radio exempts de licence. L'exploitation est autorisée aux deux conditions suivantes:

- (1) l'appareil ne doit pas produire de brouillage, et
- (2) l'utilisateur de l'appareil doit accepter tout brouillage radioélectrique subi, même si le brouillage est susceptible d'en compromettre le fonctionnement.

**WARNING****1. FOR OUTDOOR USE:**



To reduce the risk of fire or electric shock, do not expose this apparatus to rain or moisture.

**2. UNDER WET LOCATION:**

Apparatus should not be exposed to dripping or splashing and no objects filled with liquids, such as vases should be placed on the apparatus.

**3. SERVICE INSTRUCTIONS:**

**CAUTION** - These servicing instructions are for use by qualified service personnel only. To reduce the risk of electric shock, do not perform any servicing other than that contained in the operating instructions unless you are qualified to do so.

CAUTION

RISK OF ELECTRIC SHOCK  
DO NOT OPEN

 This symbol indicates that dangerous voltage constituting a risk of electric shock is present within this unit.

 This symbol indicates that there are important operating and maintenance instructions in the literature accompanying this unit.

**Disposal** Dispose of any unusable devices or batteries responsibly and in accordance with any applicable regulations.



2005-08-15

Disposing of used batteries with domestic waste is to be avoided!

Batteries / NiCad cells often contain heavy metals such as cadmium(Cd), mercury(Hg) and lead(Pb) that makes them unsuitable for disposal with domestic waste. You may return spent batteries/accumulators free of charge to recycling centres or anywhere else batteries/accumulators are sold.

By doing so, you contribute to the conservation of our environment!