

**road 15A****TWO WAY POWERED  
STAGE MONITORS**

>> **Bi-amplified 2-way system**

>> **550 W low frequency 3rd Generation Class-D power amplifier**

>> **220 W high frequency 3rd Generation Class-D power amplifier**

>> **15" speaker (3" voice coil)**

>> **3" diaphragm compression driver, 1.5" exit**

The Road 15A is a 2-way powered stage monitor that incorporates a 15R4 cone loudspeaker for bass reproduction. High frequencies are handled by an M-75 compression driver with 1.5" exit, a 3" titanium diaphragm and EFV voice coil. The 60° x 40° rotatable horn allows for high frequency coverage options when the situation calls for it.

The bi-amplified system uses a 3G Class "D" amplifier. With a 24-bit DSP providing FIR (Finite Impulse Response) filters, unparalleled control over critical signal parameters can be accomplished.

The monitor's low profile design, side mounted handles, and strategically located skid plates allow for ease of use onstage. Hidden connector plugs and indicator LEDs offer an undistractive reference for the artist and a clean stage appearance.

Housed in the birch plywood enclosure finished with durable Iso-Flex black paint and sturdy speaker grilles for "performer's abuse", the Road-15A is available in Left or Right hand versions.

**Technical Specifications**

Nominal LF Power Amplifier	550W
Nominal HF Power Amplifier	220W
Input Type	Balanced
Input Impedance	Line: 20 kohms
Sensitivity	Line: 1,55V (+ 6dBu)
On-axis Frequency Range (-10dB)	47 Hz - 23 kHz (EQ Monitor)
Maximum Peak SPL at 1m,	134 dB
HF Horn Coverage Angles (-6dB)	40° x 60°
Enclosure Material	Birch Plywood
Finish	Isoflex Black Paint
Transducers / Replacement Parts	LF: 1 x 15R4 / GM 15R4 HF: 1 x M-75 / GM M-75
Connectors	ANALOG INPUT: Female XLR LOOP THRU ANALOG: Male XLR AC INPUT: PowerCon NAC 3 FCA AC LOOP THRU: PowerCon NAC 3 DFCB
AC Power Requirements	115 V, 50 Hz/60 Hz 230 V, 50 Hz/60 Hz
Current Draw (1/3 power @ 230V)	1.7A
Shut-down Voltage	85V @ 115V 170V @ 230V
Dimensions (H x W x D)	37.1 x 74.7 x 48 cm (14.6 x 29.4 x 18.9 in)
Weight	27.3 Kg (60 lb)
Accessories (optional)	TRD-2 TRD-6

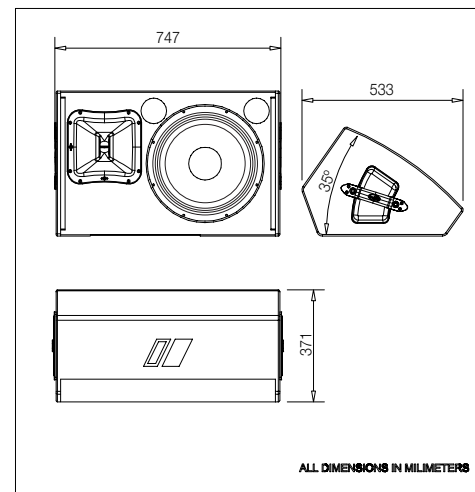
**Dimensions**

ALL DIMENSIONS IN MILLIMETERS

1. Measured maximum peak level

**Frequency Response**

Shows the frequency response of one unit, radiating to a half space environment, at the position of the ear and driven by a -20dBu swept sine wave signal.

Black: Monitor EQ.  
Red: Main EQ.

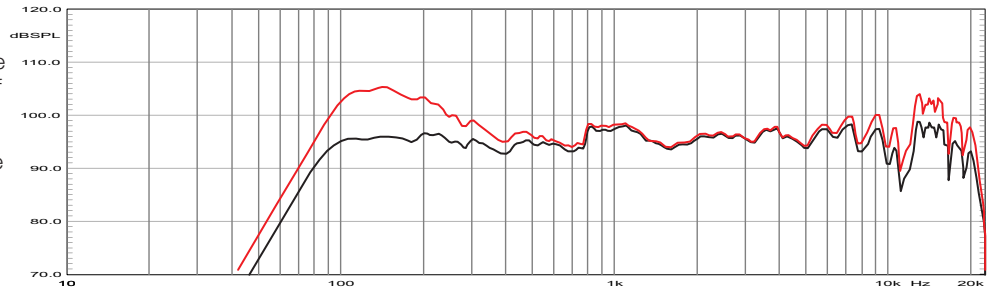

**Distortion**

Shows the Second Harmonic Distorsion (grey) and Third Harmonic Distorsion (dotted) curves for a unit driven by a swept sine wave signal (-10 dBu input).

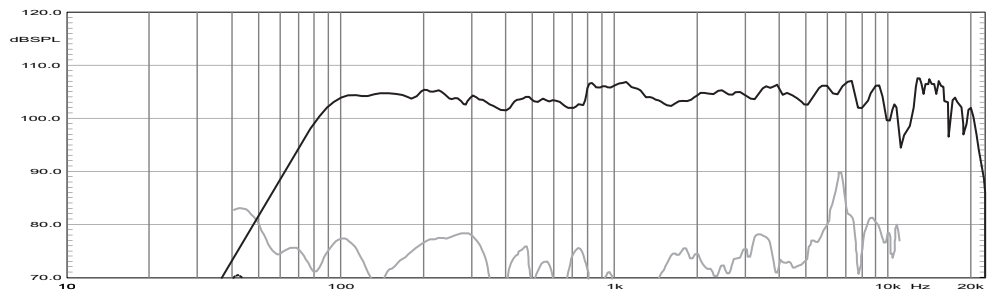

**Horizontal Directivity of two units, HF drivers outside (Recommended).**

Shows normalized horizontal isobar plot for two units, with the Low Frequency drivers next to each other. 1/12th octave resolution.

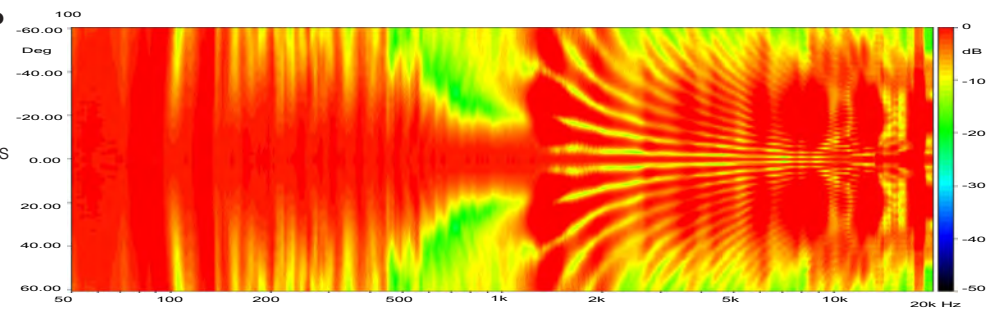
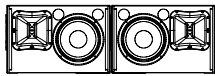

**Horizontal Directivity of two units, HF drivers inside.**

Shows normalized horizontal isobar plot for two units, with the High Frequency drivers next to each other. 1/12th octave resolution.

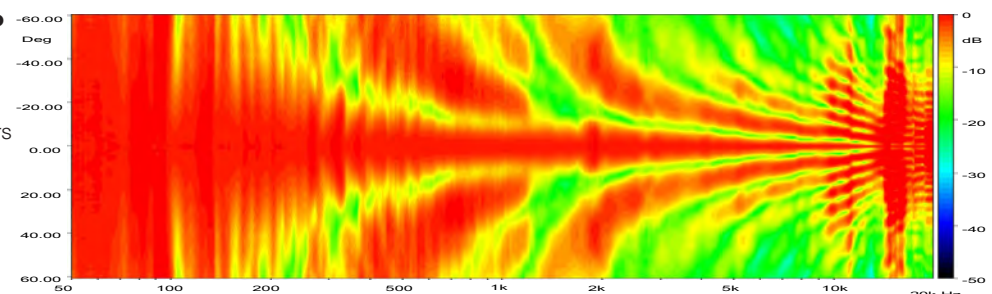
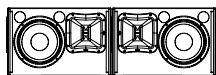

**Measurements setup.**

All measurements have been made to reflect real-life usage conditions, with the monitor on the floor and the microphone placed on the HF axis at the position where the ear of an average height person would be. Isobar directivity plots were obtained in a closed space to resemble a practical application.



NOTES: Frequency response measured outdoors at a distance of 1.95m (6.5ft) from the front grille. For identification of potential feedback frequencies, only light smoothing (1/12th octave) has been used.

Product improvement through research and development is a continuous process at D.A.S. Audio. All specifications subject to change without notice.



**D.A.S. Audio S.A.**  
C/ Islas Baleares, 24  
46988 Fuente del Jarro  
Valencia - SPAIN  
Tel. 961 340 525 - Tel. Intl. +34 961 340 860  
Fax 961 340 607 - Fax Intl. +34 961 340 607

**D.A.S. Audio of America Inc.**  
Sunset Palmetto Park - 6816 NW 77th Court  
Miami, FL 33166 U.S.A.  
Tel. 305 436 0521 - Fax. 305 436 0528  
Toll Free: 1 888 DAS 4 USA

**D.A.S. Audio Asia Pte. Ltd.**  
25 Kaki Bukit Crescent # 01-00/ 02-00  
Kaki Bukit Techpark I - Singapore 416256  
Co. Reg. No. 200704134E  
Tel. +65 6742 0151 - Fax. +65 6742 0157

[www.dasaudio.com](http://www.dasaudio.com)