

# Installation Manual

## Intellivox ADC-V90 & ADC-H90 models

(SKU: IVX-576125, IVX-577125, IVX-577135, IVX-576126, IVX-577126 and IVX-577136)

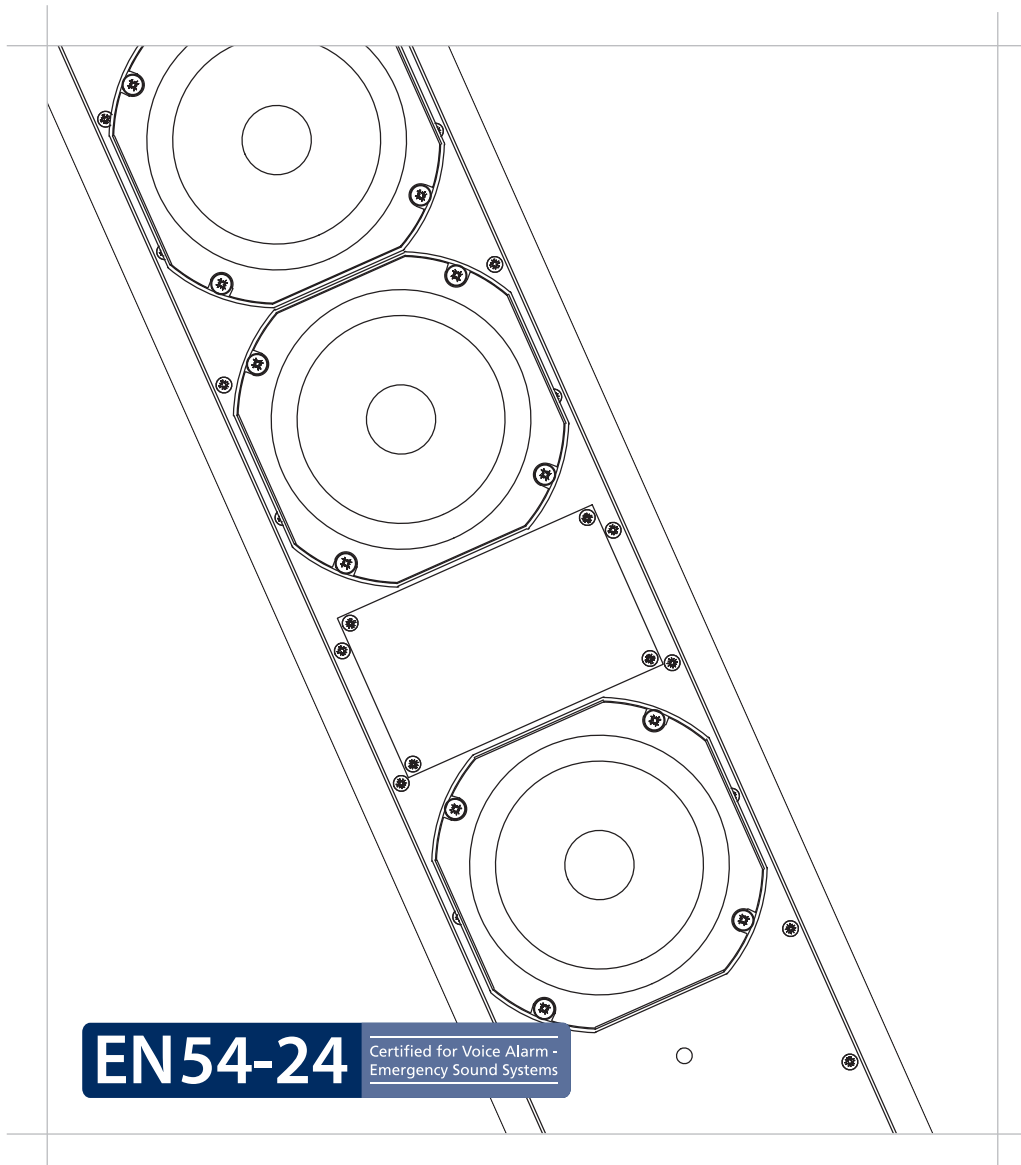

## EC DECLARATION OF CONFORMITY



This document confirms that the product manufactured by Harman Professional Kft. and described hereafter is in conformity with the following directive(s) and meets the requirements of the following standard(s):

Applicable directive(s)	LVD 2014/35/EU (see note 1)		
Applicable standard(s)	Not applicable	Provided options	Not applicable
Product details:			
Construction product description	Loudspeaker for voice alarm systems for fire detection and fire alarm systems for buildings		
Product model/type	ADC-V90 ADC-H90		
Document references:			
Datasheet(s)	202011/V90_2.5 (ADC-V90 datasheet) 202011/H90_2.5 (ADC-H90 datasheet)		
Other references	Not applicable		
Manufacturer:			
Name	Harman Professional Kft.		
Address	Szilva u. 1-3. H-7632 Pecs Hungary		
Web	www.jblpro.com		
Authorized by			
Place and date of issue	Pecs – October 24, 2018		
Notes:			
1. Only if connected in accordance with the manufacturer's instructions to mains operated audio equipment with safety properties according to the relevant harmonized standards.			

**Declaration of Performance**  
 According to Construction Products Regulation (CPR) 305/2011  
 No: 2014-001

<b>1.</b>	<b>Unique identification code of the product-type:</b>	
	ADC-V90 ADC-H90	
<b>2.</b>	<b>Type, batch or serial number or any other element allowing identification of the construction product as required pursuant to Article 11(4):</b>	
	Each product has a unique serial number specified on the product label	
<b>3.</b>	<b>Intended use or uses of the construction product, in accordance with the applicable harmonised technical specification, as foreseen by the manufacturer:</b>	
	Construction product	Loudspeaker for voice alarm systems for fire detection and fire alarm systems for buildings
	Intended use	Fire safety
	Harmonised technical specification	EN 54-24:2008 Fire detection and fire alarm systems Part 24: Components of voice alarm systems - Loudspeakers
	Provided options	Type B
<b>4.</b>	<b>Name, registered trade name or registered trade mark and contact address of the manufacturer as required pursuant to Article 11(5):</b>	
	Name	Harman Professional Kft.
	Address	Szilva u. 1-3. H-7632 Pecs Hungary
	Web	www.jblpro.com
	Branding/Trade name	Models are sold under both AXYS & JBL brand names

5.	<b>Where applicable, name and contact address of the authorised representative whose mandate covers the tasks specified in Article 12(2):</b>	
	Not applicable	
6.	<b>System or systems of assessment and verification of constancy of performance of the construction product as set out in Annex V:</b>	
	System 1	
7.	<b>Declaration of performance concerning a construction product covered by a harmonised standard:</b>	
	Notified body details:	
	Name	Scientific and Research Centre for Fire Protection named after Józef Tuliszkowski - National Research Institute
	Identification	CNBOP-PIB-1438
	Address	Nadwisłanska 213 Street 05- 420 Józefów Poland
	Web	www.cnbop.pl
	EC certificate of conformity	1438-CPR-0306
	ITT report	No. 5136/BA/11
8.	<b>Declaration of performance concerning a construction product for which a European Technical Assessment has been issued:</b>	
	Not applicable	

<b>9. Declared performance:</b>		
Essential characteristics	Performance	Harmonised technical specification EN 54-24:2008 - Type B
Frequency response limit	Passed	Section 4.2
Reproducibility	Passed	Section 5.2
Rated impedance	Passed	Section 5.3
Horizontal and vertical coverage angles	Passed	Section 5.4
Maximum sound pressure level	Passed	Section 5.5
Durability	Passed	Section 4.3
Construction	Passed	Section 4.4
Marking and data	Passed	Section 4.5
Rated noise power (durability)	Passed	Section 5.6
Enclosure protection	Passed	Section 5.18
Dry heat (operational)	Passed	Section 5.7
Dry heat (endurance)	Passed	Section 5.8
Cold (operational)	Passed	Section 5.9
Damp heat, cyclic (operational)	Passed	Section 5.10
Damp heat, steady state (endurance)	Passed	Section 5.11
Damp heat, cyclic (endurance)	Passed	Section 5.12
Sulfur dioxide corrosion (endurance)	Passed	Section 5.13
Shock (operational)	Not applicable	Section 5.14
Impact (operational)	Passed	Section 5.15
Vibration, sinusoidal (operational)	Passed	Section 5.16
Vibration, sinusoidal (endurance)	Passed	Section 5.17

<p><b>10.</b></p>	<p><b>The performance of the product identified in points 1 and 2 is in conformity with the declared performance in point 9.</b></p> <p><b>This declaration of performance is issued under the sole responsibility of the manufacturer identified in point 4.</b></p>	
	<p>Place and date of issue</p>	<p>Pecs - October 24, 2018</p>

## USER'S NOTICE AND DISCLAIMER

No part of this manual including the software described in it may be reproduced, transmitted, transcribed, stored in a database system or translated without the express written permission of JBL Professional.

Documentation kept by the end user for back-up purposes is excluded from the above.

All products and corporate names mentioned in this manual may be registered trademarks or copyrights of their respective companies. They are used here for indicative purposes only.

The information contained in this manual has been carefully checked for accuracy; however no guarantee is given with respect to its correctness. JBL Professional accepts no responsibility or liability for any errors or inaccuracies that may appear in this manual or the products and software described in it.

Specifications and information contained in this manual are subject to change at any time without notice.

© 2020 JBL Professional. All rights reserved.

## TABLE OF CONTENTS

EC declaration of conformity .....	2
Declaration of Performance .....	3
User’s Notice and disclaimer.....	7
<b>1. Important Safety Instructions .....</b>	<b>10</b>
<b>2. Introduction .....</b>	<b>11</b>
Applicable models, and variants .....	11
What’s in the packaging .....	12
<b>3. Installation Guide .....</b>	<b>13</b>
Preparing for Installation .....	13
Intellivox ADC connections .....	13
Mechanical Installation .....	14
Model V90 only .....	14
Model H90 only .....	15
Mounting Options .....	15
Model V90 only .....	16
Mounting Procedure .....	17
Wiring Details .....	18
Correction EQ and High-Pass Filter .....	19
Securing the front grill.....	19
Pilot-tone indicator .....	20
<b>4. Appendices .....</b>	<b>21</b>
Optional Accessories .....	21



# 1. IMPORTANT SAFETY INSTRUCTIONS



This symbol is intended to alert you to the presence of uninsulated dangerous voltages within the product's enclosure that may be of sufficient magnitude to constitute a risk of electric shock.



This symbol is used throughout this manual and is intended to alert you to the presence of important instructions.

- 1) Read these instructions.
- 2) Keep these instructions.
- 3) Heed all warnings.
- 4) Follow all instructions.
- 5) Do not use this apparatus near water.
- 6) Clean only with dry cloth.
- 7) Do not block any ventilation openings. Install in accordance with the manufacturer's instructions.

8) Do not install near any heat sources such as radiators, heat registers, stoves, or other apparatus (including amplifiers) that produce heat.

9) Only use attachments/accessories specified by the manufacturer.



10) Use only with the cart, stand, tripod, bracket or table specified by the manufacturer, or sold with the apparatus. When a cart is used, use caution when moving the cart/apparatus combination to avoid injury from tip-over.

11) Refer servicing to qualified service personnel. Servicing is required when the apparatus has been damaged in any way, liquid has been spilled or objects have fallen into the apparatus, the apparatus does not operate normally, or has been dropped.



**Warning** -The installer should ensure that the mechanical mounting method employed should be capable of supporting four times the weight of the unit (i.e., with a safety factor of 4). Always use both of the brackets provided with the unit.

## 2. INTRODUCTION

This manual describes the recommended installation procedure for the JBL Intellivox ADC range of loudspeakers.

The ADC range are compact 100 V/70 V line units intended for use in a wide variety of Public Address and Voice Alarm (PA/VA) systems. They are particularly suitable for installation in reverberant spaces such as railway and bus stations, airports, places of worship, shopping centres, etc., where high quality speech reproduction is required.

The JBL Intellivox ADC device is a loudspeaker type known as passive loudspeaker array, in which multiple drive units are mounted in the housing at specific spacings. In addition to the drivers, the Intellivox ADC housing contains a set of passive filters. When properly applied, the Intellivox ADC device is capable of achieving a constant SPL for mid-band frequencies over the listening area, whilst minimizing the 'spill' to other areas.

### Other key features include:

- Pilot tone indication
- Protection (glass + thermal fuse and ceramic terminal block)
- EQ correction and high-pass filter

### This manual covers:

- Wiring and connection details
- Mechanical installation of the loudspeaker

Please note that a full range of optional mounting brackets and connection coverboxes are available.



Please refer to our website for further details.

### APPLICABLE MODELS, AND VARIANTS

The Intellivox ADC range is available in two versions:

- Model V90 – for vertical mounting  
(SKU: IVX-576125, IVX-577125 and IVX-577135)
- Model H90 – for horizontal mounting  
(SKU: IVX-576126, IVX-577126 and IVX-577136)

This manual is applicable to both models. However, some factors arising from the two models' different physical configurations result in some sections of the manual text being strictly applicable to only the V90 or the H90. These sections are clearly indicated.

Apart from the passive filters, the two models are both electrically identical and can use the same mounting brackets. However their effective areas of coverage are very different, and the decision as to which is specified in a particular installation will be dictated by the specifics of the building or space.

*fig.1.1 Model V90 – for vertical mounting*

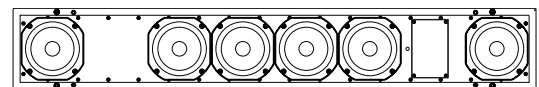
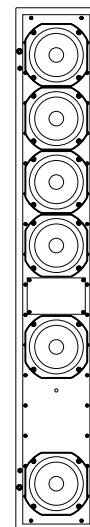

*fig.1.2 Model H90 – for horizontal mounting*

## WHAT'S IN THE PACKAGING

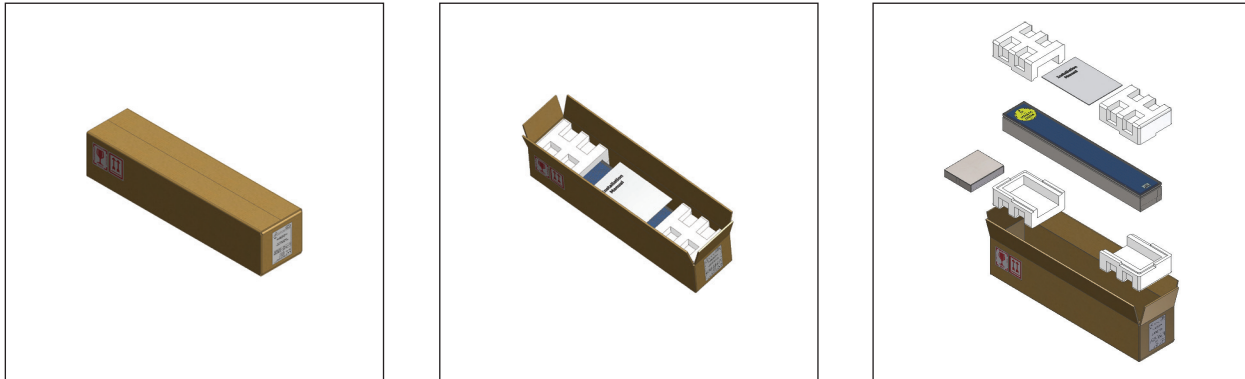

In addition to the loudspeaker itself, each unit is packed with the following items:

- Installation manual (this document)
- ADC Datasheet
- Box containing:

REF	ITEM	QTY	USE
A	Mounting brackets	2	Speaker mounting
B	30 mm hex-headed screws with washers and wall plugs	4	Mounting bracket fixings (wall)
C	M5 x 12 mm pan-head screws with shakeproof washers	8	Mounting bracket fixings (loudspeaker)
D	M4 x 10 mm round-head screws with star retaining washers (inc. hex key)	4	Grill security screws

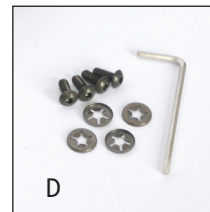
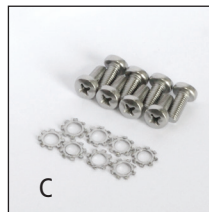
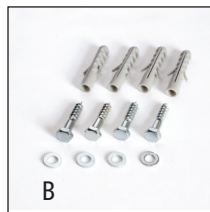
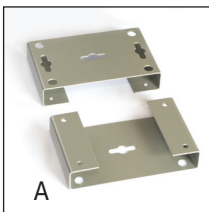

fig.2 Box contents

## 3. INSTALLATION GUIDE

### PREPARING FOR INSTALLATION

Before starting to install the Intellivox ADC loudspeaker, a number of points should be considered.

- It is assumed that the installation site has been the subject of an extensive DDA investigation or optimisation prior to the actual install. (DDA = Digital Directivity Analysis, the JBL proprietary simulation software for these products\*). This procedure will have identified the optimum physical location for the Intellivox ADC, to accurately achieve the desired acoustic coverage. In particular, the “acoustic centre” position in terms of height above the finished floor, and any mechanical mounting angles will have been specified. The installer should confirm that he/she has this information.
- Unless specified otherwise by the sound system designer, the Intellivox ADC Model V90 should be installed at a position exactly perpendicular to the listening plane (i.e. vertical if the floor is horizontal). Unlike conventional loudspeaker systems, minor mechanical misalignment may lead to degraded coverage and intelligibility. Ensure (by use of a levelling device such as a spirit level) that the surface to which the Intellivox is to be attached is absolutely vertical and that both mounting bracket positions are in the same plane. This restriction does not apply to the Model H90, which is intended to be tilted downwards.

### INTELLIVOX ADC CONNECTIONS

The Intellivox ADC range loudspeakers are designed to be connected to 100 V or 70 V line speaker distribution systems. They are not intended to be used with amplifiers which are designed to drive only low-impedance (i.e. 4 - 8 ohms) loudspeakers. However, such amplifiers may be used if intermediate 100 V/70 V line transformers are connected between the amplifier outputs and the loudspeakers.

Suitable power amplifiers for use with the Intellivox ADC range include the AXYS PB-400 and PB-800 models.

In most situations, installation will be simplified by running the speaker cables to the intended location before attempting to mechanically mount the Intellivox speakers. If the loudspeaker is being used as part of a Voice Alarm application, it is likely that fire-resistant (pyro) cable will be required; local regulations covering these requirements should always be checked and followed.

The cable entry gland at the rear of the ADC models can accept cable with a maximum diameter of 13.5 mm. Ensure that the cable being installed does not exceed this.

Wiring details can be found on page 14.

*\*Authorized electro-acoustic consultants or ‘build & design’ sound contractors can download DDA from our website [www.jblpro.com](http://www.jblpro.com)  
For further information please refer to the Help files and manual with the DDA software.*

## MECHANICAL INSTALLATION

### Acoustic Centre

Mounting an Intellivox ADC loudspeaker is a straightforward procedure, but it is essential to understand that the precise mounting location is extremely critical. The correct mounting location is defined as part of the acoustical design process and the installer should make sure that he/she has this information before commencing to mount the Intellivox ADC.



fig.3 Sticker showing acoustic centre and unit orientation

### MODEL V90 ONLY

The correct operational height defined by the system designer is the height of the Intellivox ADC's acoustic centre (reference point). This point does not necessarily coincide with the position of any particular physical component on the unit. The location of the speaker's acoustic centre is marked by the centre of the yellow sticker on the front face of the unit at the time of shipping, and it is this position that must correspond to the operational height defined in the design process.

The vertical position of the acoustic centre of the Model V90 is towards the top of the unit, as indicated by the yellow sticker (see fig.3). The horizontal position is on the vertical centre line.

When calculating the positions for the mountings (see below), the distance from the acoustic centre to the top or bottom of the loudspeaker (whichever is being used as the reference datum) should be measured and then allowed for when marking the mounting positions. The specification sheet supplied with each loudspeaker includes a mechanical drawing clearly showing the mounting position locations.

The V90 will normally be mounted perpendicular to the listening plane, i.e. vertically when the floor is a conventional horizontal plane. However, if the DDA investigation has specified a downward angle for some reason, this angle must be adhered to in the mounting process. This is likely to necessitate the use of spacers on the upper mounting bracket.

Because of the tightly-controlled vertical radiation pattern of the V90, a small deviation from the calculated acoustical mounting height or vertical mounting angle may cause severe degradation of the expected performance.

Note also that the yellow sticker indicates which way is "up"; ensure that this orientation is observed.

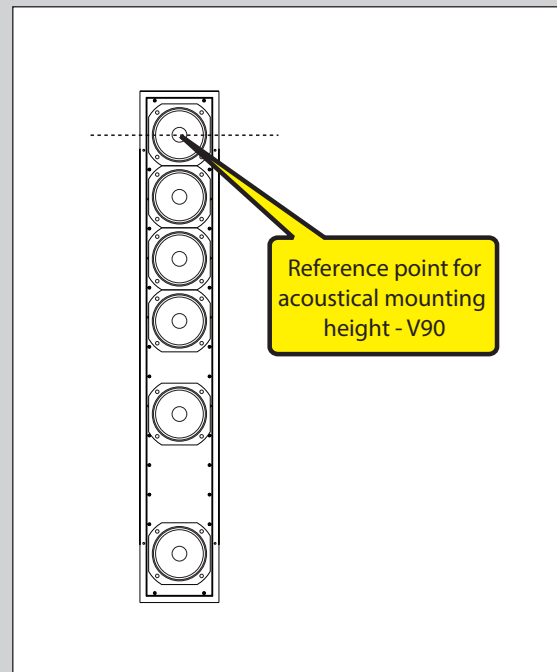

fig.4.1 Acoustic centre reference point for V90

### MODEL H90 ONLY

The location of the acoustic centre of the Model H90 is in the centre of the unit, both horizontally and vertically. This is indicated by the yellow sticker on the front grill.

The H90 should be mounted accurately so that its acoustic centre is at the position identified by the site survey.

The arrangement of drivers in the H90 differs from the V90; for this reason, a different set of measurements needs to be accurately made. For the H90, the critical aspects of the mounting position are that the horizontal (long) axis of the enclosure should be precisely horizontal, and that if the H90 is not being mounted against a wall (i.e., suspended from a pole or similar arrangement), the azimuth angle – the angle about the enclosure’s central vertical axis – should also be exactly that specified by the DDA survey. Further to these criticalities, the angle of rotation about the horizontal axis should also be carefully checked to ensure that the “downwards” radiating angle of the unit is correct.

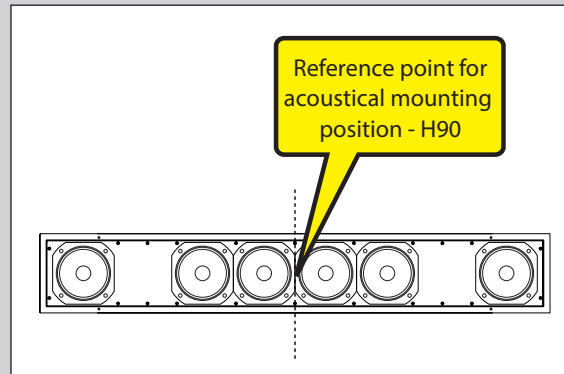

fig.4.2 Acoustic centre reference point for H90

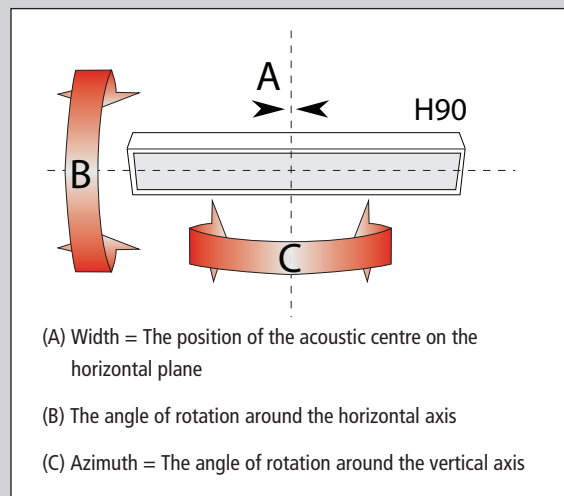

fig.4.3 H90 further mounting information

### MOUNTING OPTIONS

Intellivox ADC models have two attachment points at the rear of the enclosure; the loudspeaker should be mounted using these points. Each point consists of four M5 threaded inserts and only the screws supplied with the original mounting hardware should be used.

Cavity walls can sometimes be problematical when high-power loudspeakers are mounted on them. The internal wall cavity may resonate at one or more frequencies, degrading the audio performance significantly. Installers are advised to insert rockwool or similar sound-absorbing material into the cavity in the vicinity of the loudspeaker when mounting an Intellivox on a wall of this type.

Intellivox datasheets, which include a full range of optional brackets for various situations, can be downloaded from <http://www.jblpro.com>

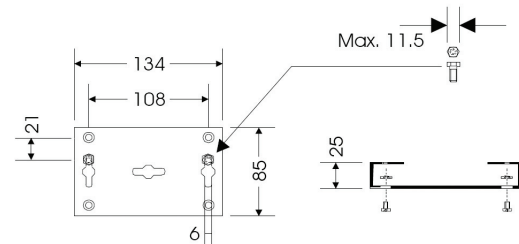

fig.5.1 - Standard bracket dimensions in mm

**MODEL V90 ONLY**

Model V90 only: There are three options for mounting the Intellivox ADC Model V90:

1. The first (and most often used) method is to use the standard mounting brackets supplied with the unit. Dimensions of the bracket are shown in fig.5.1.

The standard brackets allow mounting of the Intellivox ADC Model V90 on a straight wall or on a curved surface (e.g., a pillar) with a gap of 25 mm (1.0") between the rear of the enclosure and the wall.

The mounting procedure is given on page 13 under "Mounting Procedure".

2. A second method is to mount the Model V90 using (optional) swivel brackets which allow the plane of the column's vertical radiating axis to be at an angle other than 90 degrees to the wall. In this case two swivel brackets are needed. The horizontal angle of the swivel brackets can be secured by the hexagonal nut. The swivel brackets are mounted to the rear of the enclosure by the four M5 pan head screws instead of the standard brackets. Two versions of swivel brackets are available,

permitting the Intellivox to be rotated through 45 or 90 degrees either way respectively. Refer to page 17 for ordering information.

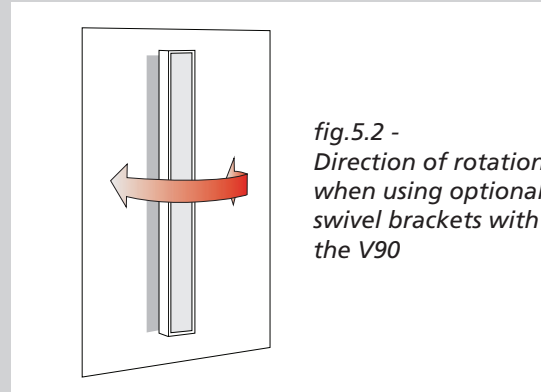

*fig.5.2 -  
Direction of rotation  
when using optional  
swivel brackets with  
the V90*

3. The third method is to mount the column within a recess in the wall or dedicated mounting panel so that the front of the unit is flush. This is a specialised mounting situation which will be encountered only rarely. Access to the rear of the unit will still be required for the cables. Because of the proximity of the unit to the walls, particular attention should be paid to the avoidance of acoustic resonances (see page 11).

**MODEL H90 ONLY**

Model H90 only: Unlike the V90, considerable flexibility exists in the mounting possibilities of the H90. The H90 is not specifically designed to be mounted on a vertical (or angled) wall. The method of mounting employed in a particular installation will be primarily dictated by the downwards angle at which the H90 needs to be mounted to achieve the coverage calculated during the DDA analysis.

Custom mounting hardware may be required to achieve the correct mounting angle. Small mounting angles may be realised using the standard mounting brackets (supplied) in conjunction with suitable spacers.

The standard mounting brackets supplied with the unit may be employed if the Model H90 is to be fixed "flat" onto a vertical wall.

Note that the provided locking mechanism of the optional hinges and swivel brackets is not suitable for the standard (horizontal) mounting method.

## MOUNTING PROCEDURE

The general procedure for mounting the Intellivox ADC Models V90 or H90 using the standard brackets is described below. It is assumed that cabling for connection to the 100 V/70 V line system has been run to the loudspeaker location.

Proceed as follows:

1. Use of the wall plugs and hexagon head screws supplied is recommended. If using other types, ensure that the "across-flats" head size does not exceed 11.5 mm (0.45").
2. Mark and drill the holes (8 mm) for the wall plugs. For the V90 use the two holes with the slots running vertically as reference. For H-90 use the slotted hole in the centre of the bracket as reference.
3. Insert the plugs and screws into the holes. Tighten the screws with a spanner, but stop with a few mm of screw shaft visible between the head and the wall.
4. Check that it is possible to slide a bracket over the heads.
5. Check that the chosen mounting points will position the column in the correct vertical angle specified by the acoustic design (in the case of the Model V90, this is usually exactly perpendicular to the listening area). Use spacers on one or both brackets if necessary.
6. Attach the brackets to the rear of the loudspeaker using the M5 x 12 pan-head screws and shakeproof washers supplied. The 10 mm diameter holes allow screwdriver access to the screw heads.

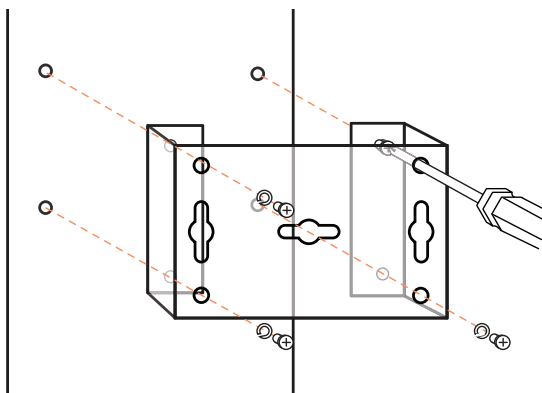

fig.6 - Bracket attachment

7. Remove the front grill from the loudspeaker by gently lifting it at the locations of the 'snap-on' fittings which hold it in place. Remove the protective foam. Unscrew the four self-tapping screws securing the connector compartment cover and remove the cover.

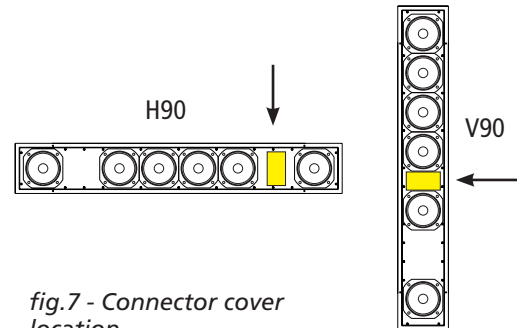

fig.7 - Connector cover location

8. Lift the loudspeaker and slide the brackets over the heads of the hex-head screws protruding from the wall, and at the same time feed the speaker cable through the cable entry gland at the rear and into the connector compartment so that it is free and accessible from the front. Tighten the rear gland, leaving sufficient free cable to connect to the terminal block.
- !** Ensure that the gland fits tightly around the cable jacket. The enclosure protection, as well as the LF SPL response, will deteriorate in case of a leaky enclosure.
9. Firmly fasten the screws securing the brackets to the wall with the spanner. Re-check the verticality (or other angle if specified) with a spirit level or similar levelling device.
  10. The loudspeaker connections should now be made – see section on Wiring Details on page 14.



## WIRING DETAILS

When the Intellivox ADC has been mounted in the correct position, it may be connected up. Connection is straightforward; having passed the cable through the gland, connect the speaker feed to the '100 V' and '0' terminals of the ceramic connection block.



Always ensure that the amplifier is powered down before wiring the loudspeaker. If the audio suddenly becomes live there is a strong risk of electric shock.

The third terminal, marked with an Earth (Ground) symbol, allows a separate earthing connection to be made to the loudspeaker. This provides a low impedance circuit to earth from the metalwork of the enclosure, as often required by safety regulations. If the loudspeaker enclosure is mounted on a support that offers a low impedance connection to the safety ground, the earth terminal of the ceramic connection block can be directly wired to the mounting support as indicated in fig.8.1. If a safety ground connection is not available in the vicinity of the mounting location, the wiring scheme as indicated in fig.8.2 can be used. Note that the application dependent safety regulations should be consulted in order to determine the proper grounding scheme.

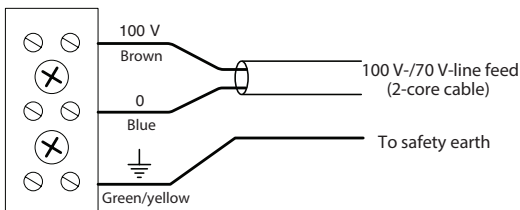

fig.8.1 - Wiring details A

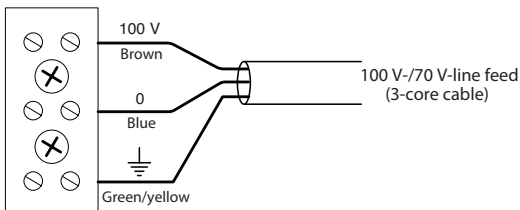

fig.8.2 - Wiring details B

## TAP SETTING

The internal 100 V/70 V transformer's primary tapping should be set according to the power requirements of the installation. This figure will have been determined at the time of site analysis; see also the Maximum SPL figures in the specifications table on the data sheet.

The tapping is set by means of an internal switch that is located behind the inspection plate as indicated in fig.9.2 (Model V90) and fig.9.3 (Model H90). This switch has three positions, labelled 100 W, 50 W and 25 W. These figures relate to the speaker use on a 100 V line system, lower powers are available from a 70 V line system.

The table below summarises the output powers:

Tap Switch setting	Max. output power (W)	
	100 V line system	70 V line system
100 W	100	50
50 W	50	25
25 W	25	12.5

fig.9.1 - Tap settings

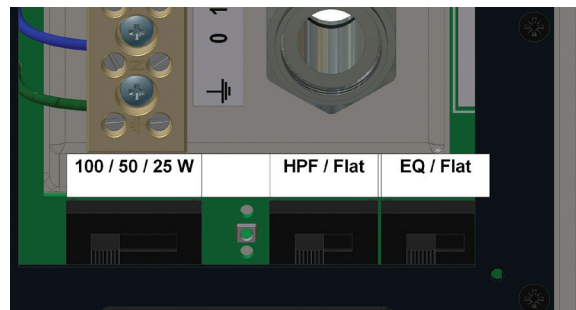

fig.9.2 - Switch locations (Model V90)

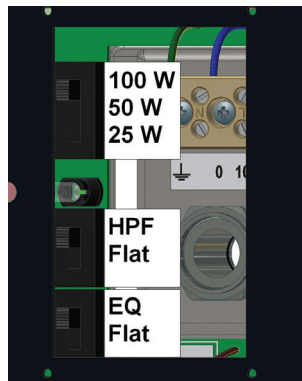

fig.9.3 - Switch locations (Model H90)

## CORRECTION EQ AND HIGH-PASS FILTER

Many building PA systems will include some provision for equalization (EQ) adjustment at the signal processing stage, or within the power amplifier (as with the AXYS PB-400 and PB-800 amplifiers). Adjusting EQ to achieve maximum system intelligibility is a normal part of the commissioning process, though it should be noted that measured intelligibility will be greatly affected by several other factors not immediately under the designer’s control, such as reverberation time and ambient noise levels. If external EQ adjustment is not available, it may be desirable in some applications to modify the frequency response of the loudspeaker itself.

The frequency response can be altered by means of two switches labelled ‘EQ’ and ‘HPF’. These switches are located behind the inspection plate as indicated in fig.9.2 (Model V90) and fig.9.3 (Model H90).

The EQ switch has two positions. The EQ is disabled if the switch is in the ‘Flat’ position. The mid-cut EQ correction is indicated in fig.10.1 (Model V90) respectively fig.10.3 (Model H90). The factory default setting is with EQ enabled (flattest SPL versus frequency response). If the EQ is disabled the maximum achievable SPL is somewhat higher, at the expense of a SPL response that is less flat.

The HPF (high-pass filter) switch also has two positions. The high-pass filter is disabled if the switch is in the ‘Flat’ position. The frequency response of the high-pass filter is indicated in fig.10.2 (Model V90) respectively fig.10.4 (Model H90). The filter response is slightly dependent on the tap setting, the curves are valid for the 100 W tap. The factory default setting is with the high-pass filter enabled, this setting is most suitable for voice applications.

Note that the high-pass filter might have to be disabled in case of 3rd-party line monitoring applications that make use of a DC signal. DC will be blocked by a series capacitor if the high-pass filter is enabled.

If the monitoring system uses an end-of-line unit, and DC input to the loudspeaker should be blocked, the high-pass filter should be enabled. If the monitoring system is to be used in conjunction with the loudspeaker(s), without end-of-line unit, the high-pass filter should be disabled.



Note that this does not apply to the integral load monitoring of the AXYS PB-400/PB-800 Industry Amplifiers; these amplifiers do not use a DC signal for load monitoring purposes.

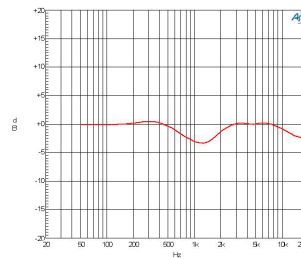

fig.10.1 - V90 correction EQ

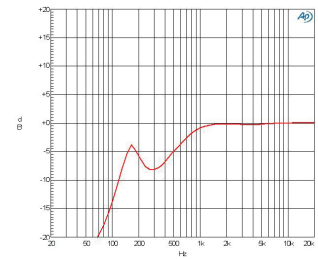

fig.10.2 - V90 high-pass filter

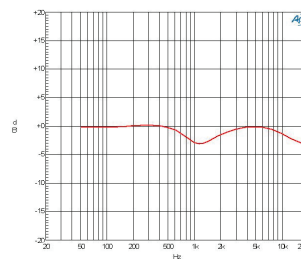

fig.10.3 - H90 correction EQ

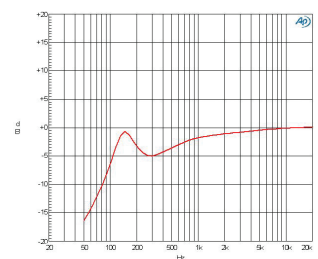

fig.10.4 - H90 high-pass filter

## SECURING THE FRONT GRILL

**Option 1.** After making the connections and setting the power tapping, the front grill may be replaced. Do not replace the protective foam! Align the four locating spigots with the four larger holes in the back of the grill frame and push the grill back on, ensuring that all four spigots locate positively with the retaining clips within the holes.

**Option 2.** The front grill may be secured more permanently with the (supplied) M4 security screws. These need to be fitted one at a time before replacing the grill.

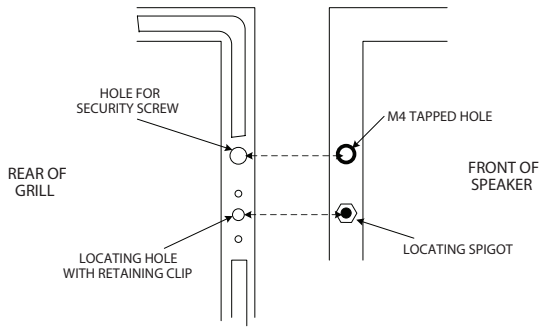

fig.11 - Securing the front grill

Insert a screw through the larger hole in the corner of the grill rear flange by feeding it from the inside of the flange, so that the thread of the screw protrudes from the rear of the grill. Push a retaining washer (supplied with the screws) over the screw thread, and up against the metalwork to retain the screw in position. Repeat for the other three corners.

Push the grill into place using the locating spigots as previously described. Insert the hex key supplied through holes in the grill itself to tighten the security screws into the M4 tapped holes.

## PILOT-TONE INDICATOR

In many PA/VA systems, a high-frequency pilot-tone is continuously fed to the loudspeakers for load monitoring purposes. This permits load and cable integrity to be constantly verified. A LED is fitted to the front panel of the ADC range of speakers, which illuminates on detection of a pilot-tone. The LED is visible with the grill installed, and is a useful check that the system is operational.

The AXYS PB-400 and PB-800 amplifiers include a suitable pilot-tone generator; other manufacturers' equipment may also be suitable. The pilot-tone should be in the frequency range 20 to 23 kHz, and of at least 6 Vrms amplitude (note that this level is not dependant on the tap setting, the detection process is most sensitive for frequencies around 21 kHz) for the LED to illuminate. Pilot-tones of other frequencies and/or levels may be used if the fault monitoring system demands them; the illumination of the LED is not essential for such a system to operate correctly.

## SPEAKER PROTECTION

In a PA/VA system, it is important that the failure of a single loudspeaker does not incapacitate the rest of the system. The ADC range of speakers incorporate three protection systems to prevent this.

1. The glass fuse is designed to protect against excessive current being drawn by the unit. The fuse is a standard 20 mm diameter 1 A anti-surge type. Only replace this with a fuse of the same type and rating. In the event of the fuse needing replacement, remove the protective cap from the fuseholder. The fuse can be removed from the holder by inserting a small screwdriver or similar through the holes in the top of the holder. Refer to fig.12.1 (Model V90) and fig.12.2 (Model H90).
2. ADC units also incorporate a separate thermal fuse in series with the 100 V/70 V input. This is intended as fail-safe device, which goes open-circuit if the internal temperature becomes excessive, such as would occur in the event of a fire. Thus a local fire which damages a single speaker on a system does not cause other speakers elsewhere to fail, as the damaged unit is removed from the speaker circuit.
3. A ceramic connector ensures that the terminal will not melt in a fire situation and short out the audio line.

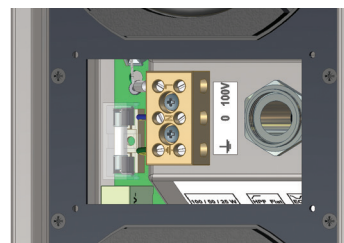

fig.12.1 - Fuse location (Model V90)

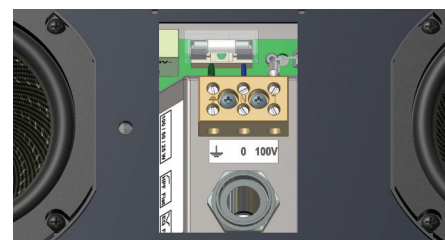

fig.12.2 - Fuse location (Model H90)

## 4. APPENDICES

### OPTIONAL ACCESSORIES

Listed below are some optional accessories which may be required for a particular installation.

DESCRIPTION	ORDER SKU
Intellivox wall bracket set (2 pcs), 25 mm, RAL 9007	IVX-802227
Intellivox hinge bracket 90°, RAL 9007	IVX- 802005
Intellivox swivel bracket 90°, RAL 9007	IVX- 806668
Intellivox swivel bracket 45°, RAL 9007	IVX- 806678
Intellivox wall bracket set (2 pcs), 25 mm, RAL 9010	IVX- 802225
Intellivox hinge bracket 90°, RAL 9010	IVX- 802000
Intellivox swivel bracket 90°, RAL 9010	IVX- 806608
Intellivox swivel bracket 45°, RAL 9010	IVX- 806618



**JBL Professional**  
8500 Balboa Boulevard  
Northridge, CA 91329 U.S.A.

© Copyright 2020 JBL Professional  
[www.jblpro.com](http://www.jblpro.com)