



## ***User's Manual***

# ***æro<sup>2</sup> series***

**AERO-40A**



Antes de utilizar el equipo, lea la sección "Precauciones de seguridad" de este manual. Conserve este manual para futuras consultas.

Before operating the device, please read the "Safety precautions" section of this manual. Retain this manual for future reference.

## CONTENTS

<b>SAFETY PRECAUTIONS</b> .....	<b>3</b>
<b>WARRANTY</b> .....	<b>4</b>
<b>DECLARATION OF CONFORMITY</b> .....	<b>5</b>
<b>INTRODUCTION</b> .....	<b>6</b>
<b>CONFIGURATIONS</b> .....	<b>7 - 8</b>
16 AERO-40A + 12 LX-218CA	
24 AERO-40A + 18 LX-218CA	
<b>SPECIFICATIONS</b> .....	<b>9</b>
<b>LINE DRAWINGS</b> .....	<b>9</b>
<b>AMPLIFIER</b> .....	<b>10 - 12</b>
Description	
ON / OFF	
Overload Indicators	
Equalisation	
Overheating	
Low mains voltage	
Current consumption	
Troubleshooting	
<b>CHANGE OF CONFIGURATION</b> .....	<b>13 - 16</b>
<b>RIGGING SYSTEM</b> .....	<b>17 - 18</b>
<b>ANNEX I</b> .....	<b>19</b>
Line connections: unbalanced and balanced	
<b>ANNEX II</b> .....	<b>20</b>
DASnet cables	

### Cajas acústicas activas / Self-powered loudspeaker enclosures

El signo de exclamación dentro de un triángulo indica la existencia de importantes instrucciones de operación y mantenimiento en la documentación que acompaña al producto. Conserve y lea todas estas instrucciones. Siga las advertencias. **ATENCIÓN:** Es un producto clase A, por lo que en entornos domésticos puede causar radio-interferencias, en cuyo caso el usuario tendrá que tomar las medidas oportunas. De acuerdo con EN55103-2, usar el equipo sólo en entornos E1, E2, E3 ó E4.



The exclamation point inside an equilateral triangle is intended to alert the users to the presence of important operating and maintenance (servicing) instructions in the literature accompanying the product. Heed all warnings. Follow all instructions. Keep these instructions.

**WARNING:** This is a class A product. In a domestic environment this product may cause radio interferences in which case the user may be required to take adequate measures.

Use this product only in E1, E2, E3 or E4 environments according to EN55103-2.

Do not remove mains connector ground, it is dangerous and illegal. Class I device. The product must be connected to a mains socket outlet with protective earth connection. Only use this equipment with an appropriate mains cord for your country.

No desconecte la tierra en el conector de alimentación pues es peligroso e ilegal. Equipo de Clase I. El producto debe ser conectado a un enchufe con toma de tierra. Sólo use este equipo con el cable de red de alimentación adecuado para su país.

El signo del rayo con la punta de flecha, alerta contra la presencia de voltajes peligrosos no aislados. Para reducir el riesgo de choque eléctrico, no retire la cubierta.



The lightning and arrowhead symbol warns about the presence of uninsulated dangerous voltage. To reduce the risk of electric shock, do not remove the cover.

No instale el aparato cerca de ninguna fuente de calor como radiadores, estufas u otros aparatos que produzcan calor. Debe instalarse siempre sin bloquear la libre circulación de aire por las aletas del radiador.

Do not install near any heat sources such as radiators, heat registers, stoves or other apparatus that produce heat. The circulation of air through the heatsink must not be blocked.

No exponga este equipo a la lluvia o humedad sin el protector de lluvia recomendado. No exponga el equipo a salpicaduras sin el protector de lluvia recomendado, ni coloque sobre él objetos que contengan líquidos, tales como vasos y botellas.

Do not expose this device to rain or moisture without the rain protector supplied. Do not place any objects containing liquids, such as bottles or glasses, on the top of the unit. Do not splash liquids on the unit without the rain protector supplied.

Este símbolo indica que el presente producto no puede ser tratado como residuo doméstico normal, sino que debe entregarse en el correspondiente punto de recogida de equipos eléctricos y electrónicos.



This symbol on the product indicates that this product should not be treated as household waste. Instead it shall be handed over to the applicable collection point for the recycling of electrical and electronic equipment.

Equipo diseñado para funcionar entre 15°C y 45°C con una humedad relativa máxima del 95%, con un rango de  $\pm 10\%$  de la tensión nominal de alimentación indicada en la etiqueta trasera (según IEC 60065). Si debe sustituir el fusible preste atención al tipo y rango.

Working temperature ranges from 15°C to 45°C with a relative humidity of 95%, with  $\pm 10\%$  of the rated main voltage value indicated on the rear label (according to IEC 60065). If the fuse needs to be replaced, please pay attention to correct type and ratings.

El cableado exterior conectado al equipo requiere de su instalación por una persona instruida o el uso de cables flexibles ya preparados.

The outer wiring connected to the device requires installation by an instructed person or the use of a flexible cable already prepared.

Si el aparato es conectado permanentemente, la instalación eléctrica del edificio debe incorporar un interruptor multipolar con separación de contacto de al menos 3mm en cada polo.

If the apparatus is connected permanently, the electrical system of the building must incorporate a multipolar switch with a separation of contact of at least 3mm in each pole.

Para desconectar el dispositivo debe usar el enchufe. Desconecte este aparato durante tormentas eléctricas, terremotos o cuando no se vaya a emplear durante largos periodos.

To disconnect the device, you should use the mains plug. Unplug this apparatus during lightning storms, earthquakes or when unused for long periods of time.

No emplace altavoces en proximidad a equipos sensibles a campos magnéticos, tales como monitores de televisión o material magnético de almacenamiento de datos.



Do not place loudspeakers in proximity to devices sensitive to magnetic fields such as television monitors or data storage magnetic material.

El colgado del equipo sólo debe realizarse utilizando los herrajes de colgado recomendados y por personal cualificado. No cuelgue la caja de las asas y respete los valores máximos de carga dados en el manual.

The appliance should be flown only from the rigging points and by qualified personnel. Do not suspend the box from the handles and respect the maximum load values given in the manual.

No existen partes ajustables por el usuario en el interior de este equipo. Cualquier operación de mantenimiento o reparación debe ser realizada por personal cualificado. Es necesario el servicio técnico cuando el equipo se haya dañado de alguna forma, como que haya caído líquido o algún objeto en el interior del aparato, haya sido expuesto a lluvia o humedad, no funcione correctamente, haya recibido un golpe o su cable de red esté dañado.

No user serviceable parts inside. Refer all servicing to qualified service personnel. Servicing is required when the apparatus has been damaged in any way, such as power-supply cord or plug is damaged, liquid has been spilled or objects have fallen into the apparatus, the apparatus has been exposed to rain or moisture, does not operate normally or has been dropped.

Limpie con un paño seco. No use limpiadores con disolventes.

Clean only with a dry cloth. Do not use any solvent based cleaners.

## **GARANTÍA**

Todos nuestros productos están garantizados por un periodo de 24 meses desde la fecha de compra.

Las garantías sólo serán válidas si son por un defecto de fabricación y en ningún caso por un uso incorrecto del producto.

Las reparaciones en garantía pueden ser realizadas, exclusivamente, por el fabricante o el servicio de asistencia técnica autorizado.

Otros cargos como portes y seguros, son a cargo del comprador en todos los casos.

Para solicitar reparación en garantía es imprescindible que el producto no haya sido previamente manipulado e incluir una fotocopia de la factura de compra.

## **WARRANTY**

All our products are warrantied against any manufacturing defect for a period of 2 years from date of purchase.

The warranty excludes damage from incorrect use of the product.

All warranty repairs must be exclusively undertaken by the factory or any of its authorised service centers.

To claim a warranty repair, do not open or intend to repair the product.

Return the damaged unit, at shippers risk and freight prepaid, to the nearest service center with a copy of the purchase invoice.



## **DECLARACIÓN DE CONFORMIDAD DECLARATION OF CONFORMITY**

DAS Audio Group, S.L.  
C/ Islas Baleares, 24 - 46988 - Pol. Fuente del Jarro - Valencia. España  
(Spain).

Declara que AERO-40A:  
Declares that AERO-40A:

Cumple con los objetivos esenciales de las Directivas:  
Abide by essential objectives relating Directives:

- de Baja Tensión (Low Voltage Directive) 2014/35/UE
- de Compatibilidad Electromagnética (EMC) 2014/30/UE
- RoHS 2011/65/UE
- RAEE (WEEE) 2012/19/UE

Y es conforme a las siguientes Normas Armonizadas Europeas:  
In accordance with Harmonized European Norms:

- EN 60065:2014.- Audio, video and similar electronic apparatus. Safety requirements.
- EN 55032:2012.- Electromagnetic compatibility of multimedia equipment. Emission requirements.
- EN 55103-2:2009.- Electromagnetic compatibility. Product family standard for audio, video, audio-visual and entertainment lighting control apparatus for professional use. Part 2:Immunity.
- EN 50581:2012.- Technical documentation for the assessment of electrical and electronic products with respect to the restriction of hazardous substances.

## INTRODUCTION

The **AERO-40A** is a 3-way powered line array system which incorporates connectivity for remote monitoring and control. The unique configuration of the **AERO-40A** Advanced Line Array System (ALAS™) incorporates a rear-loaded 12" transducer in a bass-horn configuration for low-end reproduction. The mid-range is handled by a new 8" transducer developed specifically for the **AERO-40A**. High frequency reproduction relies on two DAS **M-75N** compression drivers attached to a new **BPS-2912** waveguide.

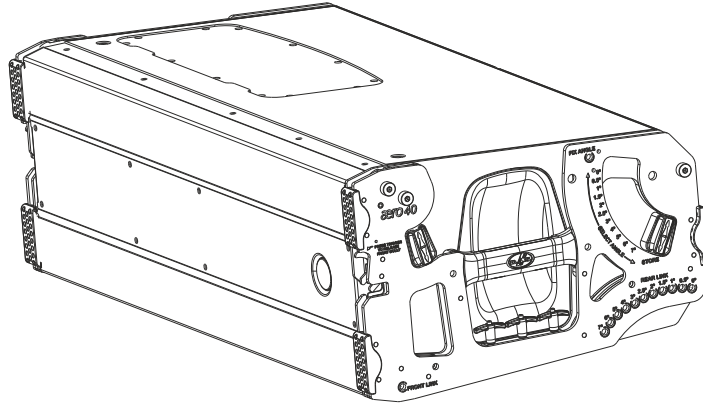

## Features

- Advanced Line Array System (ALAS™).
- Powered three-way configuration.
- 4000 Wpeak Class D power amplifier.
- Powerfull DSP with Brick wall FIR Filters.
- Full limiting and protection features.
- Lates generation of AD/DA converters.
- Remote monitoring and control via **DASnet™**.
- Newly developed high frequency waveguides.
- Higher SPL and increased power handling.
- New rigging system for improved ease of use and safety.

Power for the **AERO-40A** is provided by a package of integrated electronics that includes a new 2000 W (4000 Wpeak) amplifier, advanced digital signal processing and connectivity for remote system management. The three channel, high efficiency Class D amplifier design is equipped with a switch mode power supply (SMPS) and a comprehensive protection package for both the amplifier as well as the components. Channel two the mid-range with channel three powering the high frequency drivers.

The **AERO-40A** incorporates the latest in digital signal processors. Brick wall FIR filters have been used to provide perfect alignment between ways achieving exceptionally uniform coverage all the way down the crossover point. Top-of-the-line AD/DA converters have been employed allowing for significant improvements in dynamics, lower distortion and ultra-low noise levels.

Remote monitoring and control is provided by way of **DASnet™**, the audio management application for DAS powered cabinets and processors. The **DASnet™** software offers users instant and intuitive view of the system status as well as control over the range of parameters of a single cabinet or a network of them.

The **AERO-40A** enclosure is brilliant in design. Constructed using birch plywood and finished with the ISO-Flex black paint offers excellent protection and durability. Three individual assemblies comprising the high frequency waveguide, the horn device for 8" mid-range and the carrier of the 12" woofer are made from injection molded aluminum and attached to the front of the cabinet. A two-piece injected aluminum heat sink housing the amplifier and related electronics is attached to the rear of the cabinet.

A robust steel grille with a powder coat finish has been used to protect the components. Stainless steel has been employed to fasteners and parts of the new rigging system. The captive rigging system has been designed to provide ease-of-use, safe rigging and precise aiming. Using captive links and quick-release pins, the spring-loaded links remain positioned while rigging and prevent rattling during operation.

# CONFIGURATIONS

To continue, two configuration examples. You will find more on the web page.

Example 1 : 16 AERO-40A +12 LX-218CA

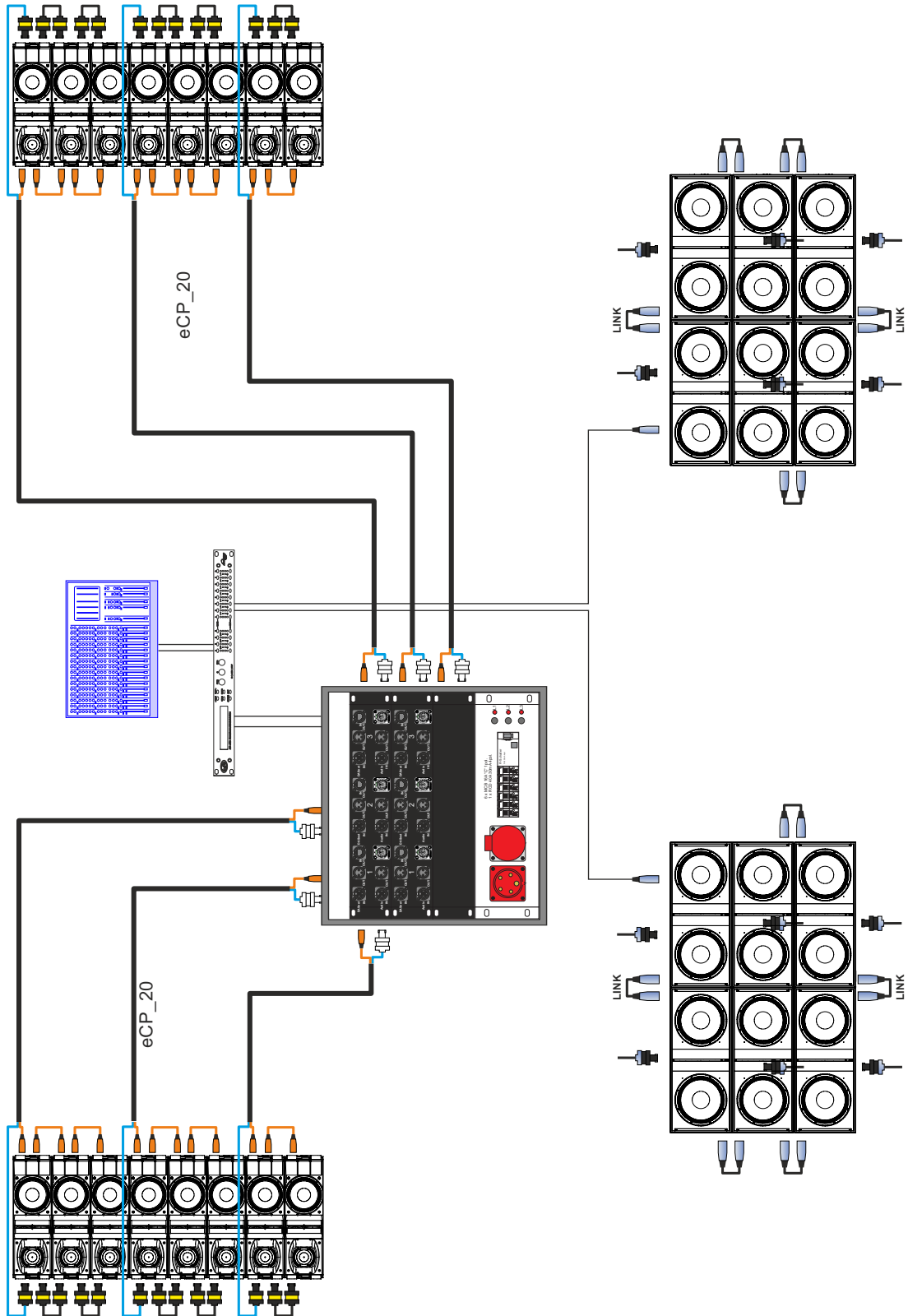

**CONFIGURATIONS (cont'd)**

Note: You will find more configurations on the web page.

**Example 2 : 24 AERO-40A +18 LX-218CA**

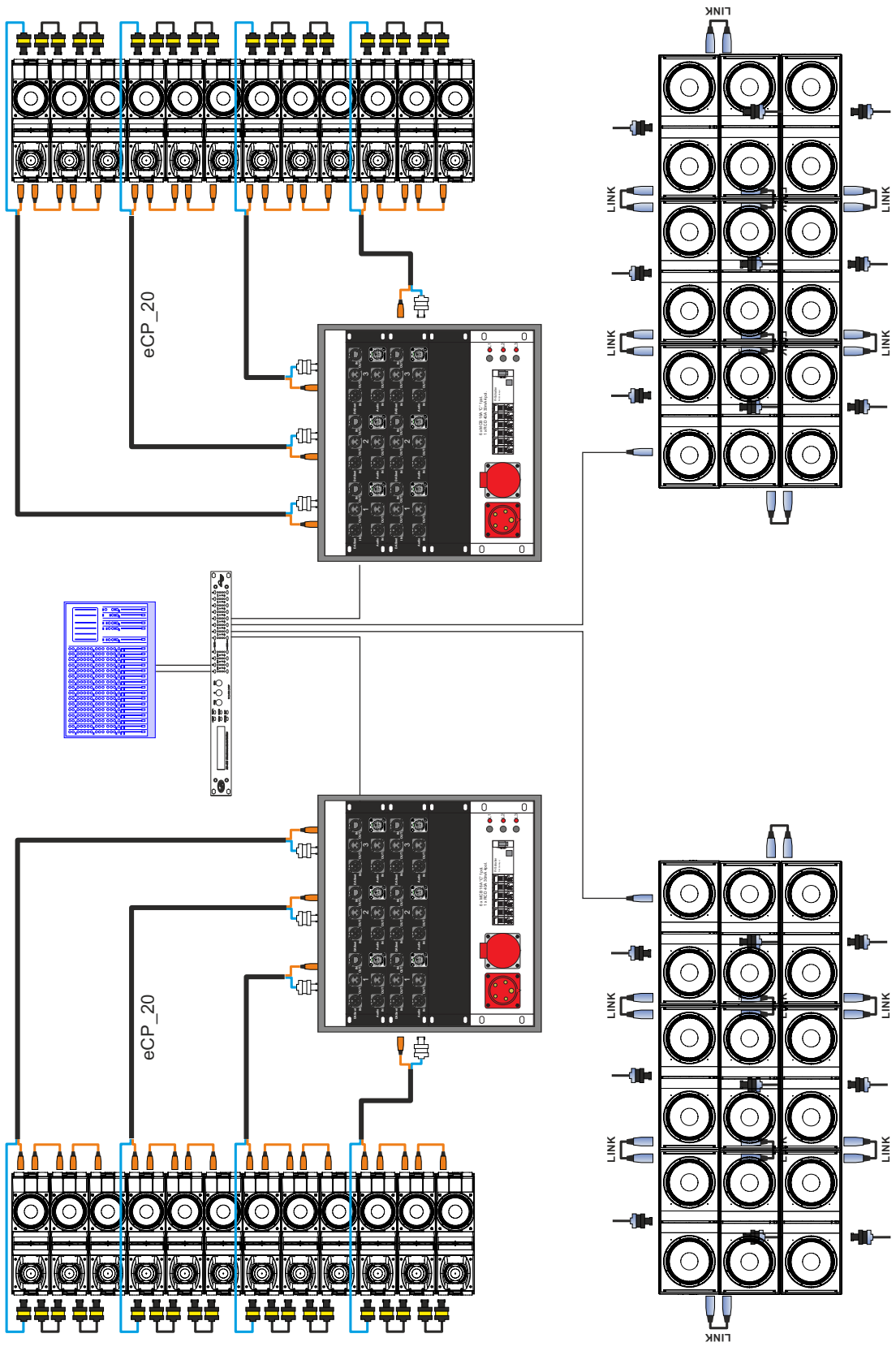



## SPECIFICATIONS

<b>AERO-40A</b>	
Nominal LF Power Amplifier	1000 W (Class D)
Nominal MF Power Amplifier	500 W (Class D)
Nominal HF Power Amplifier	500 W (Class D)
Input Type	Balanced Differential Line
Input Impedance	Line: 20 kOhms
Sensitivity	Line: 1,95 V (+8dBu)
Frequency Range (-10dB) (1)	60 Hz - 20 kHz
Horizontal Coverage (-6dB)	90° Nominal
Vertical Coverage	Splay Dependent
Rated Maximum Peak SPL at 1m (2)	138 dB
Transducers/Replacement Parts	LF: 1 x 12GNR/GM-12G MF: 1 x 8AN4/GM-8AN4 HF: 2 x M-75N/GM-M75N
Enclosure Geometry	Trapezoidal 3.5°
Enclosure Material	Birch Plywood
Color/Finish	Black/ISO-flex paint
Rigging System	Integrated in box design
Connectors	Audio INPUT: Female XLR Audio LOOP THRU: Male XLR Audio + Data INPUT: etherCON Audio + Data LOOP THRU: etherCON AC INPUT: powerCON TRUE1 AC OUTPUT: powerCON TRUE1
AC Power Requirements	6,0 A, 115 V, 50 Hz/60Hz
1/3 Power (Pink Noise)	3,0 A , 230 V, 50 Hz/60Hz
Dimensions (H x W x D)	31,5 x 94,2 x 40 cm 12,4 x 37,1 x 15,75 in
Weight	68 kg (149,6 lb)
Accessories	AX-AE40S3 Rigging Grid AXS-AE40 PICKUP-AE40S3 PL-40S DASnet Rack

**DAS Audio Group, S.L.**, continuously strives to enhance its products through investigation and development. All specifications are subject to change without prior notice.

## LINE DRAWINGS

ALL DIMENSIONS IN MILIMETERS

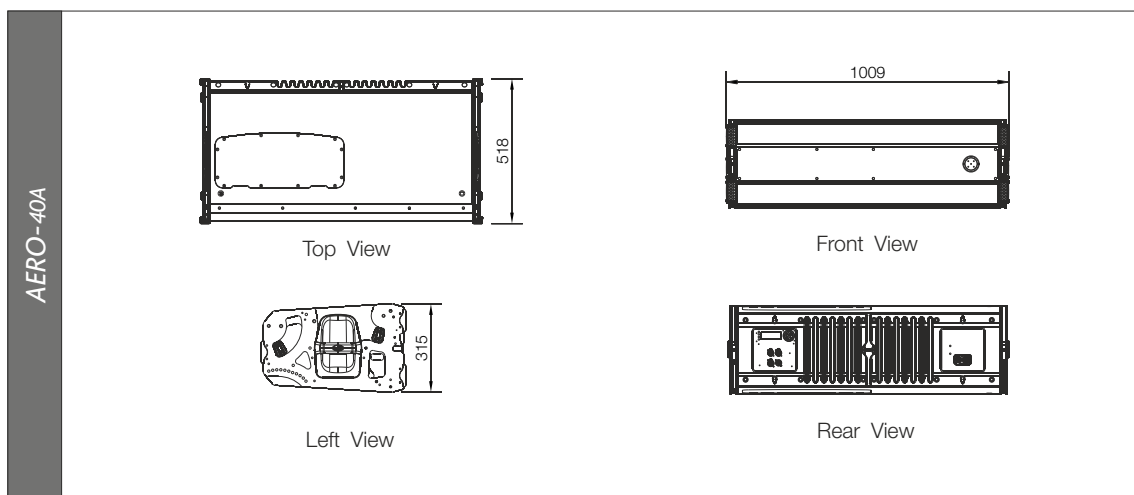

## AMPLIFIER

### Description

- 1) **INPUT :**  
XLR-type input signal connector. This is balanced connector just like the LOOP THRU connector with the following pin assignments:  
1 =GND (ground).  
2 =(+) Non inverted input.  
3 =(-) Inverted input.
- 2) **LOOP THRU :**  
XLR-type output connector for connecting several units together and sending them all the same signal.
- 3) **IN :**  
Neutrik etherCon input connector for *DASnet™*.
- 4) **OUT :**  
Neutrik etherCon output connector for *DASnet™*, for connect more cabinets.
- 5) **ON :**  
Green LED which indicated that the unit is ON.
- 6) **IDENTIFY/COMMS :**  
Orange LED which blinks slowly when IDENTIFY is pushed (to indentify the unit) or, blink faster if there is communication with *DASnet™*.
- 7) **SIGNAL/LIMIT :**  
Two color LED which indicates signal presence if shines green and limiter if shines red.
- 8) **AMP. PROTECT :**  
Red LED which indicates the protection of one or more channels (channel is shown on the screen).

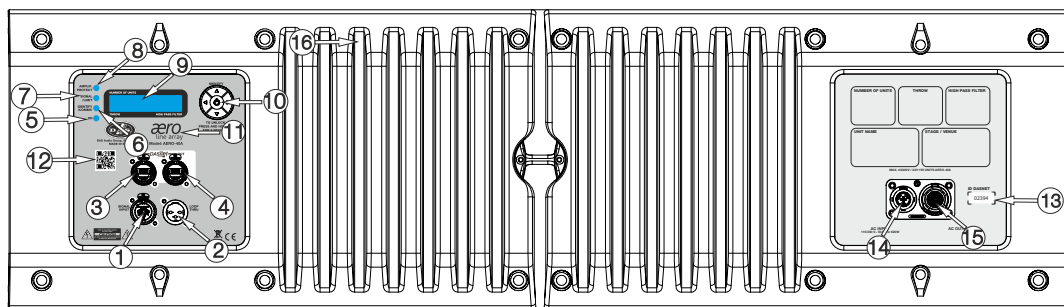

AERO-40A amplifier

- 9) **DISPLAY :**  
The 2x16 display shows messages or data.
- 10) **KEYBOARD :**  
Keyboard with 5 buttons for setting or reconfigure the unit.
- 11) **MODEL :**  
Amplifier model tag: *aero 40A*.
- 12) **QR :**  
QR symbol which allows the access, by internet, to the user's manual.
- 13) **ID DASNET :**  
Tag with the ID number of the unit for *DASnet™* (more information in SYSTEM RECONFIGURATION). This information is shown when the unit is turned on.
- 14) **AC INPUT :**  
Neutrik PowerCon TRUE1 mains connector. **Only use this equipment with an appropriate mains cord.**
- 15) **AC OUTPUT :**  
Neutrik PowerCon TRUE1 mains connector. **Only use this equipment with an appropriate mains cord.**
- 16) **RADIATOR :**  
Be careful when in contact with radiator because it can be hot, although it never will reach a dangerous temperature.

.....  
**NOTE:** The next sequency of messages are shown at power:



At last, after a few seconds, the screen turns off.  
.....

## ON/OFF

A sound system should be switched on sequentially. Switch on the self-powered units last in your sound system (switch on the subwoofer before the mid-high system). Switch on the sound sources such as CD players or turntables, then the mixer, then the processors, and finally the self-powered unit. If you have several units, it is recommended that you switch them on sequentially one at a time.

Follow the inverse order when switching off, turning self-powered units off before any other element in the sound system.

Disconnect the device by removing the mains connector from the mains socket. The mains connector and mains socket must always be freely accessible and never covered or blocked in any way.

The models use a power cable equipped with a Neutrik PowerCon TRUE1 connector. Power can be daisy chained via the TRUE1 output connector (see details on product label).

**IMPORTANT:** Do not disconnect the unit while in use.

Ensure that the device is disconnected from the mains by observing that the ON LED is turned off. Please note that the ON LED can stay on for several seconds after the mains power has been disconnected.

## Overload indicator

This device has a SIGNAL/LIMIT indicator. The red light indicates the signal is excessive.

The indicator should not be lit continuously. This distorts the signal (quickly fatiguing your ears) and may damage the speakers.

## Equalisation

The unit does not need extreme settings of equalisation to produce quality sound. Avoid high levels of gain on the equalisers. Gain values above +3 dB on a console's EQ are not recommended.

## Overheating

This equipment does not normally overheat during normal conditions of use. When overheating occurs, the unit protects itself. You should then find out why and if necessary contact an authorised dealer for technical assistance.

Normally it is enough just to let the unit cool down after you have corrected the problem so that the system functions properly again.

The amplifier is provided with a radiator made of aluminum which improves heat evacuation.

Keep grilles clean and dust-free.

Do not block or obstruct in any way the air entrance or exit while the equipment is in use.

Air circulates from the bottom to the top of the amplifier.

## Low mains voltage

If mains voltage falls below the shutdown voltage for the unit, it will stop playing. When acceptable levels are regained, the unit will switch back on automatically.

The unit recognised automatically if it's going to work in 230Vac or 115Vac range

The nominal operating ranges are 90V to 125V for 115Vac, or 180V to 250V for 230Vac..

Therefore the current consumed by a 115V version is double the 230V version to achieve the same acoustic power level.

For 230Vac the consumption of the unit giving 1/3 of power (with pink noise input signal) is 3A.

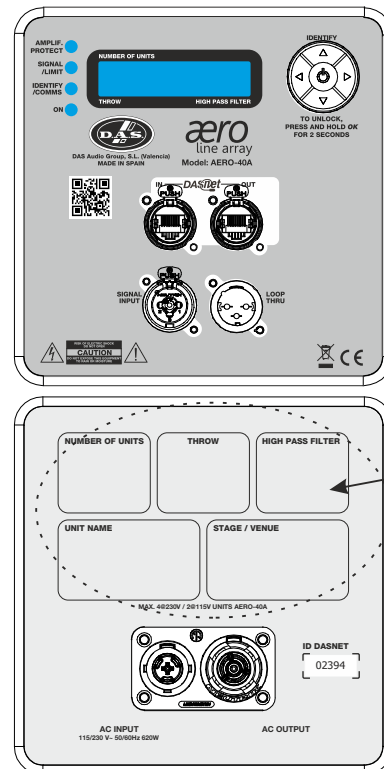

**Label details**

## Troubleshooting

PROBLEM	CAUSE	SOLUTION
No sound from the unit. The SIGNAL LED does not light up.	<p>1 – The signal source is sending no signal.</p> <p>2 – Defective cable.</p>	<p>1 – Check that the mixer or sound source is sending signal to the UNIT.</p> <p>2 – Check that the cable from the sound source to the UNIT is connected correctly. Replace the cable if defective.</p>
Full power cannot be obtained. The LIMIT LED never lights up.	<p>1 - The signal source does not have a hot enough output.</p> <p>2 - If the connections are correct, it might be overheating</p>	<p>1 - If using a mixer, use the balanced output if available. Use a professional mixer with a hotter output.</p> <p>2 - Try to “cold” the unit turning down the master of the mixer</p>
Sound is distorted. The LIMIT LED is not on, or only lights up occasionally.	<p>1 - The mixer or signal source is distorting.</p>	<p>1 - Turn mixer channel gains down. Check that none of your signal sources are distorting.</p>
Sound is distorted and very loud and LIMIT LED lights up.	<p>1 - The system is overloaded and has reached maximum power.</p>	<p>1 - Turn down the mixer's output.</p>
Hum or buzz when a mixer is connected to the unit.	<p>1.– The console probably has un-balanced outputs. You may be using an incorrect un-balanced to balanced cable.</p> <p>2.– The mixer and the powered speaker are not plugged into the same mains outlet.</p> <p>3.– The audio signal cable is too long or too close to an AC cable.</p> <p>4 - DASnet ecP_xx cable is defective.</p> <p>5 - Error in DASnet Patch panel 485 net connection.</p>	<p>1.– Read the appendix of this manual to make a correct un-balanced to balanced cable.</p> <p>2.– Connect the mixer and the unit to the same mains outlet.</p> <p>3.– Use a cable that is as short as possible and/or move the audio signal cable away from mains cables.</p> <p>4 - Check that there aren't pins crossed in CAT7 cable. Possible short between audio par and DASnet signal.</p> <p>5 - Make sure that Audio INPUT is not connected in DASnet INPUT and vice versa.</p>
Hum or buzz when using lighting controls in the same building.	<p>1.– The audio signal cable is too long or too close to the lighting cable.</p> <p>2.– On a sound system with three-phase AC, the lighting equipment and the UNIT are connected to the same phase.</p>	<p>1.– Move the audio signal cable away from lighting cables. Try to find out at what point the noise is leaking into the system.</p> <p>2.– Connect the sound system to a different phase than the lights. You may need the help of an electrician.</p>
The ON LED does not light up when the mains connector is connected and the unit is switched to ON.	<p>1.– Bad or loose AC connection to the UNIT or the mains outlet.</p> <p>2 – Faulty AC cable.</p> <p>3 - Internal fuse blown</p>	<p>1.– Check your connections.</p> <p>2.– Check the cables, connectors and AC power with a suitable mains tester.</p> <p>3 - Replace the fuse for another of the same size and type.</p>



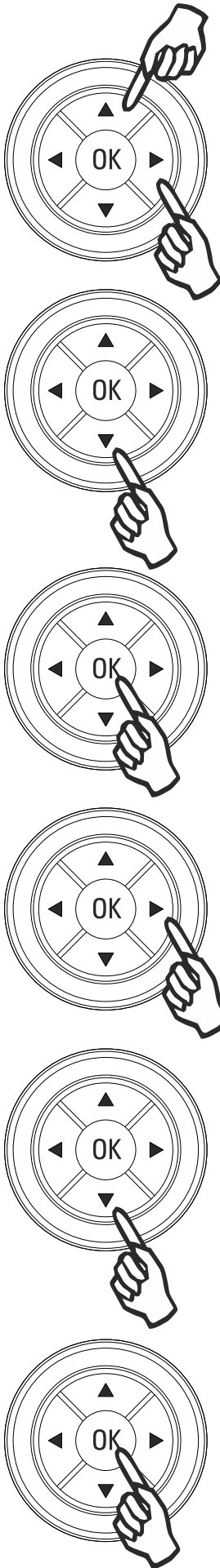

After selecting the number of array units, pushing the **Up** arrow we come back to the previous menu. If we push the **right** arrow now, we will log in to the second menu where we select the throw pushing the **down** arrow:

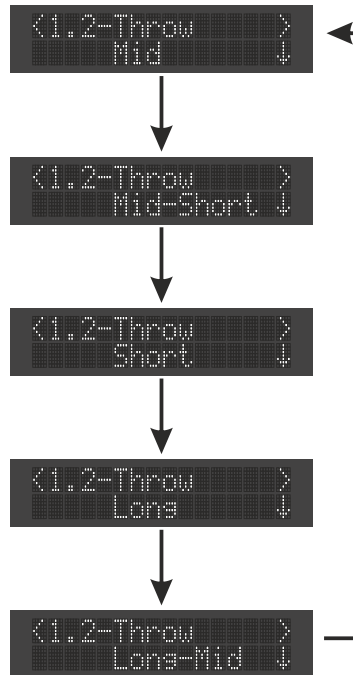

Cyclically, we could come back to any option. When the selection is made, we can exit pushing 'OK'.

If we push **right** in the 'Configuration' menu after the 'Throw' menu, we will find the menu to apply, if you wish, a high-pass filter:



Cyclically, we could come back to any option. Push 'OK' to select.

Remember that high-pass filter slopes are 48 dB/oct.



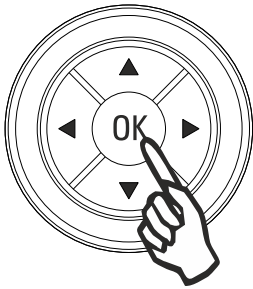

```
3-Information  
↵
```

Pushing 'OK' to select 'Information', all the information the unit will appear automatically on the screen, following the next sequence:

```
Unit Name:  
Aero 40A
```

Note: Unit Name can be changed with DASnet.

```
Unit ID number:  
02394
```

Note: In this example, the ID is 02394.

```
Firmware v1.20  
UCV1.4 - DSPV2.0
```

Note: Firmware version can be updated in the future.

```
Gain: 0.0 dB  
Delay: 0.0 ms
```

Note: 'Gain' and 'Delay' can be changed with DASnet.

```
1 Unit  
Mid :HP: OFF
```

Note: The screen will switch off in a few seconds.

```
3-Information  
↵
```

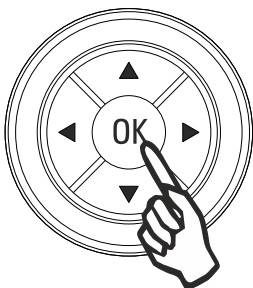

It will stop. You can push 'OK' again and all the information will appear again.



### Warning

Due to the numerous images needed to explain the **AERO-40A** array system setup, this manual can't offer all the necessary information to rig the **DAS Audio** system. In this document only we reflect the safety precautions and a summary of the elements.

To log in to the complete information, please consult **Rigging Manual**, which you will find on the web page.

To perform any operations related to flying the system, read the present document first and act on the warnings and advice given. The goal is to allow the user to become familiar with the mechanical elements required to fly the acoustic system, as well as the safety measures to be taken during set-up and teardown.

Only experienced installers with adequate knowledge of the equipment and local safety regulations should fly speaker boxes. It is the user's responsibility to ensure that the systems to be flown (including flying accessories) comply with state and local regulations.

The working load limits in this manual are the results of tests by independent laboratories. It is the user's responsibility to follow and comply with safety factors, resistance values, periodical supervisions and warnings given in this manual. Product improvement by means of research and development is on going at **DAS Audio**. Specifications are subject to change without notice.

It is common practice to apply 5:1 safety factors for enclosures and static elements. For slings and elements exposed to material fatigue due to friction and load variation the following ratios must be met; 5:1 for steel cable slings; 4:1 for steel chain slings and 7:1 for polyester slings. Thus, an element with a breaking load limit of 1000 kg may be statically loaded with 200 kg (5:1 safety factor) and dynamically loaded with 142 kg (7:1 safety factor).

When a system is flying, the working load must be lower than the resistance of each individual flying point in the enclosure, as well as each box. Hanging hardware should be regularly inspected and suspect units replaced if in doubt. This is important to avoid injury and absolutely no risks should be taken in this respect. It is highly recommended that you implement an inspection and maintenance program on flying elements, including reports to be filled out by the personnel that will carry out the inspections. Local regulations may exist that, in case of accident, may require you to prevent evidence of inspection reports and corrective actions after defects were found.

### **Absolutely no risks should be taken with regards to public safety.**

When flying enclosures from ceiling support structures, extreme care should be taken to assure the load bearing capabilities of the structures so that the installation is absolutely safe. Do not fly enclosures from unsafe structures. Consult a certified professional if needed. All flying accessories that are not supplied by DAS Audio are the user's responsibility. Use at your own risk.

### Accessories

**AERO-40A** systems are rigged with the accessories **AX-AE40S3** and **PICKUP-AX-AE40S3** (if you need another lift motor).

The platform **PL-40S** allows the transport of four units and **PL-40** (which is included on each enclosure) allows the transport of one unit.

Consult the Rigging Manual for more information about the accessories.

The metal parts are made of steel, covered with zinc and painting in black, with high resistency screws which act to reinforce the stacking and the rigging.

Next, we name the accessories with images.

## Accessories

Consult the **Rigging Manual** for more information about the accessories.

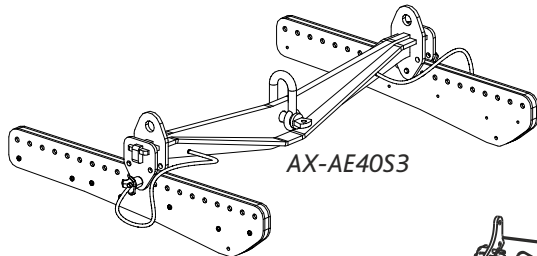

AX-AE40S3

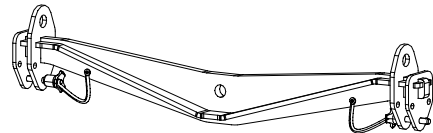

PICKUP-AX-AE40S3

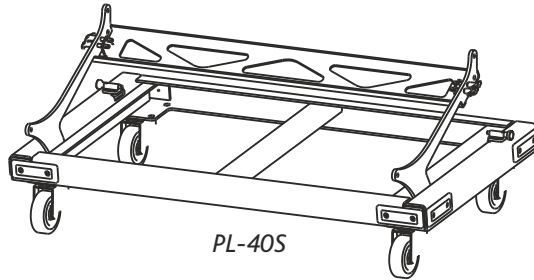

PL-40S

## Other accessories

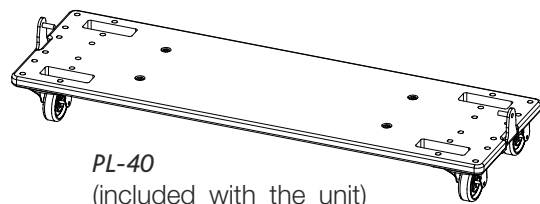
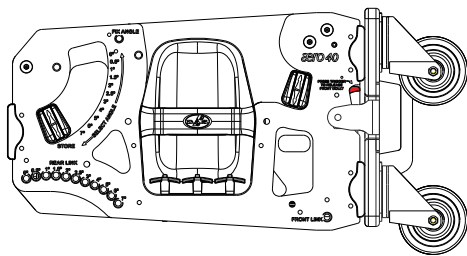

PL-40  
(included with the unit)

**DASnet rack  
(2 patch panels + power distro 32Amp)  
(European version)**

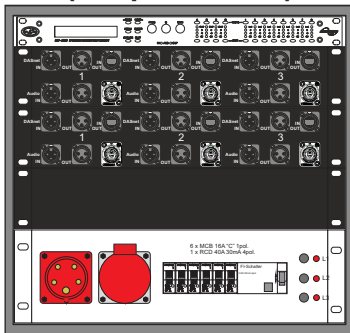

**DASnet rack  
(2 patch panels + power distro 32Amp)  
(American version)**

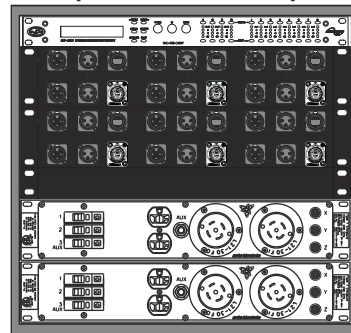

## DASnet cables

### Power Link:



*Plink1\_09*  
(number refers to cable length, meters)

### EtherCon cable (eC): Shielded STP CAT7 cable



*eC\_0,9*  
(number refers to cable length, meters)

### EtherCon cable + Powercable (eCP):



Shielded CAT7 cable  
Power cable 3x2,5mm2  
aero 40A, Convert 15A

*eCP\_20*  
(number refers to cable length, meters)



Shielded CAT7 cable  
Power cable 3x2,5mm2  
Road 12A\_net,  
Road 15A\_net

*eCPk\_1 / eCPk\_5 /*  
(number refers to cable length, meters)

## ANNEX I: Line connections: unbalanced and balanced

There are two basic ways to transport an audio signal with microphone or line level:

**Unbalanced line:** Utilising a two conductor cable, it transports the signal as the voltage between them. Electromagnetic interference can get added to the signal as undesired noise. Connectors that carry unbalanced signals have two pins, such as RCA (Phono) and ¼" (6.35mm, often referred to as jack) mono. 3 pin connector such as XLR (Cannon) may also carry unbalanced signals if one of the pins is unused.

**Balanced line:** Utilising a three conductor cable, one of them acts as a shield against electromagnetic noise and is the ground conductor. The other two have the same voltage with respect to the ground conductor but with opposite signs. The noise that cannot be rejected by the shield affects both signal conductors in the same way. At the device's input the two signals get summed with opposite sign, so that noise is cancelled out while the programme signal doubles in level. Most professional audio devices use balanced inputs and outputs. Connectors that can carry balanced signal have three pins, such as XLR (Cannon) and ¼" (6.35mm) stereo.

The graphs that follow show the recommended connection with different types of connectors to balanced processor or amplifier inputs. The connectors on the left-hand side come from a signal source, and the ones on the right hand side go to the inputs of the processor or amplifier. Note that on the unbalanced connectors on the left-hand side, two terminals are joined inside the connector. If hum occurs with balanced connections, try disconnecting the sleeve (ground) on the input connector. Note that the illustrations show what should be connected to what, but that pin locations on an actual XLR connector are different. Also, pin 2 hot is assumed on XLR connectors.

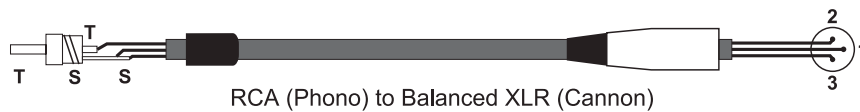
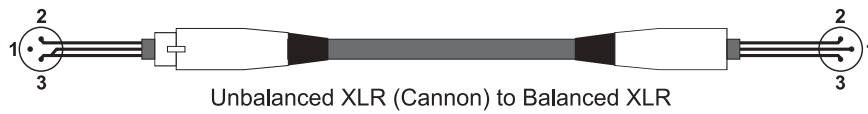
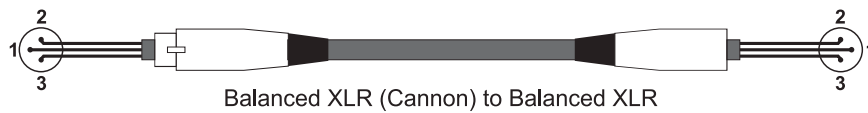

## ANNEX II : DASnet cables

With each system, **cabling and patch panels are provided**. It is very important to use the system with the intended cables to prevent electromagnetic interferences between the analog audio signal, the DASnet data and the power. Be sure to check the specifications provided by the cable manufacturer. It is also especially important when installing connectors yourself, to note that when termination is not accurate, a cable will be unable to achieve its maximum performance and could have interferences.

There are 4 different types of cables.

- The main feeds which include power and a STP, CAT7 cable. These cables are named **eCP\_xx** (xx refers to cable length).

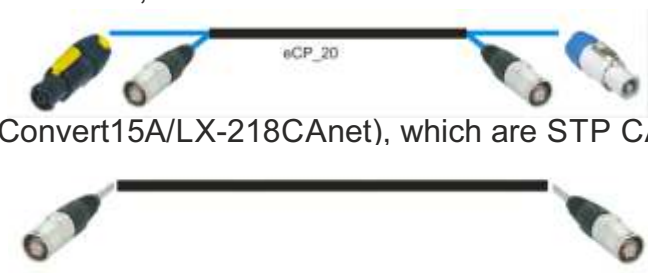

- The links between cabinets (aero40A/Convert15A/LX-218CANet), which are STP CAT7 cables. Cable code **eC\_09**



- Power Links between cabinets. Cable code **Plink1\_09**



- Links for RoadNet series. Power+STP CAT7. eCPk 1/eCPk 5



### Important

The main feed cable eCP\_xx has the following structure:

STP CAT 7 cable with Aluminium Shield for each individual pair and a main aluminium Shield.

The main Shield has to be soldered to the etherCon housing.

The eC\_09 cable is a CAT5e cable with global Aluminium Shield.

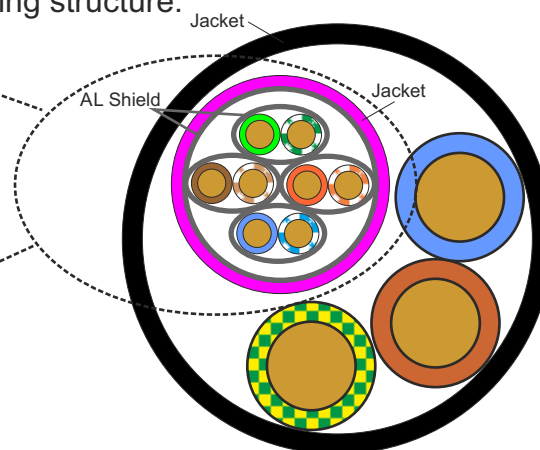

ecP\_xx: Power cable 3x2,5mm<sup>2</sup> + CAT7 4x (2 x 0,14mm<sup>2</sup>)

The pin out of the EtherCon to XLR is the following on the eCP cables:

	<b>etherCon</b>	<b>XLR</b>
1	Orange-White	Audio+ 2
2	Orange	Audio- 3
3	Green-White	Audio Earth 1
4	Blue	
5	Blue-White	
6	Green	Data Earth 1
7	Brown-White	Data- (A) 3
8	Brown	Data+ (B) 2



[www.dasaudio.com](http://www.dasaudio.com)

UM\_AE40A\_02\_EN

**DAS Audio Group, S.L.**  
C/. Islas Baleares, 24  
46988 Fuente del Jarro  
Valencia, SPAIN  
Tel. +34 96 134 0860

**DAS Audio of America, INC.**  
6900 NW 52th Street  
Miami, FL. 33166 - U.S.A.  
TOLL FREE: 1 888 DAS 4 USA

**DAS Audio Asia PTE. LTD.**  
3 Temasek Avenue, Centennial  
Tower #34-36  
Singapore 039190  
Tel. +65 6549 7760

**DAS do Brasil LTDA.**  
Rua Dos Andradas, 382 SL  
Santa Efigênia, São Paulo  
Brasil. CEP: 01208-000  
Tel. +551133330764