

# INTEGRAL-WA4

User manual

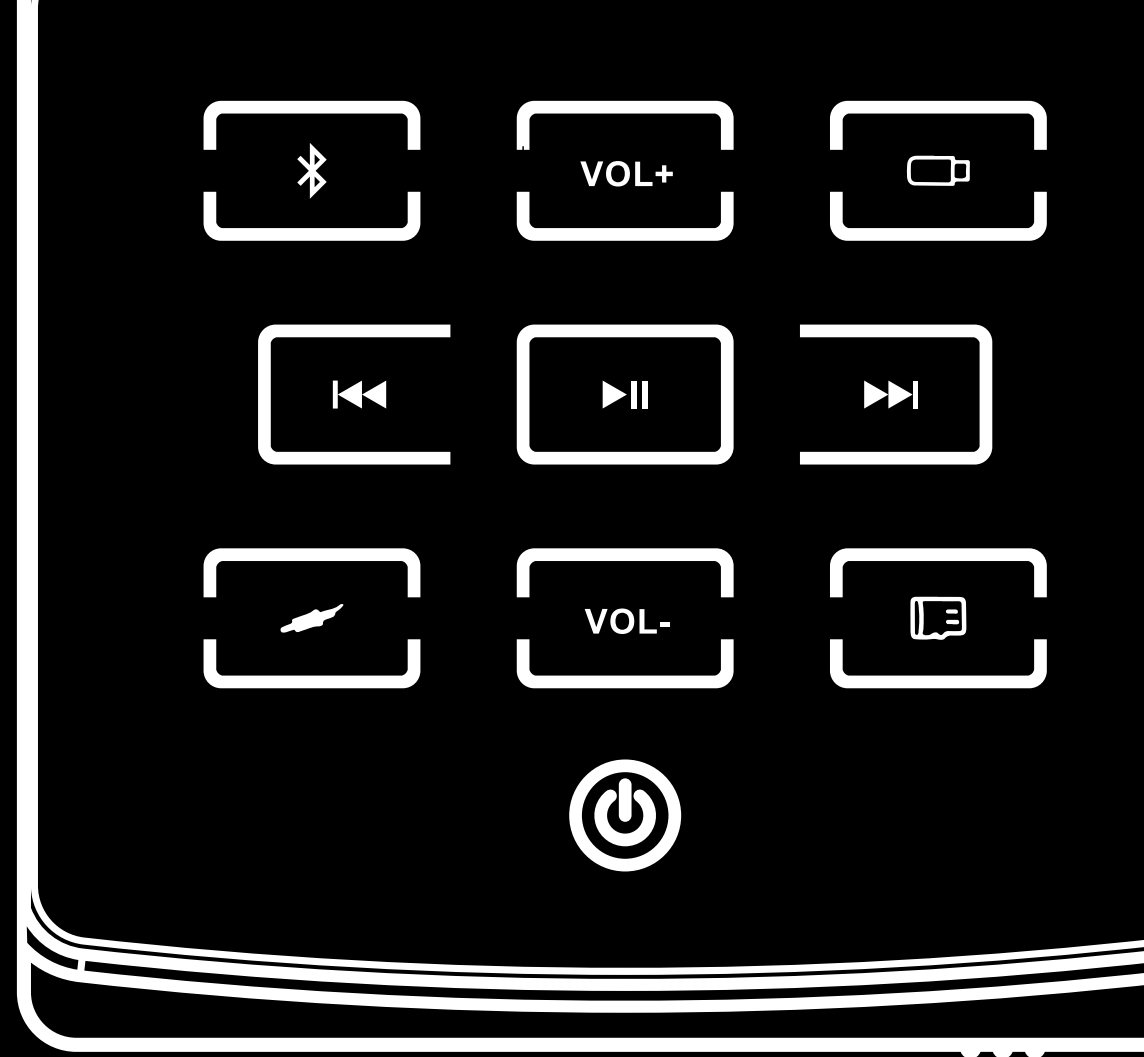

SOUND WITH SOUL

### **DAS Audio is a unique brand. We create sound solutions for businesses, always adapted to the different needs of our clients.**

The Integral Series is the heart and brain of our installation solutions. It comprises of a series of devices that in addition to feeding and processing the signal of our speakers, allow an absolute control to our users, guaranteeing the protection and quality of the equipment.

You are about to discover what it means to work with our brand, and this is just the beginning. You will have access to quality training materials on our website, where you will discover specific business solutions and learn how to use them: [dasaudio.com/en/training/](https://dasaudio.com/en/training/)

This user manual is designed to guide you, swiftly and smoothly, during the installation of our equipment, but in case you have any questions or doubts, do not hesitate to contact our technical support team by writing directly to [support@dasaudio.com](mailto:support@dasaudio.com) or, if you prefer, through our website, contacting your nearest office at [dasaudio.com/contact](https://dasaudio.com/contact)

# INTEGRAL

## Description and features

INTEGRAL-WA4 is a 4-channel compact wall amplifier equipped with USB/TF card, local line input and Bluetooth. Specially designed to be installed in the walls of commercial / educational facilities or domestic use. It uses a high-efficiency class-D amplifier for a maximum power output of 4 x 25 W, at 4ohm. The buttons at the front panel allow volume control, input source selection, etc. A remote control is also included with the unit, as well, an electrical box of 86 x 86 mm.

- 4 channel amplifier, wall-panel format
- 4 independent input sources
- 25 W per channel @ 4 ohms
- High Efficiency Class D technology
- Input Sources: Auxiliary Line, micro-SD card, USB and Bluetooth
- Universal Power Supply
- 86 x 86 electrical box included for easy installation
- Remote control included

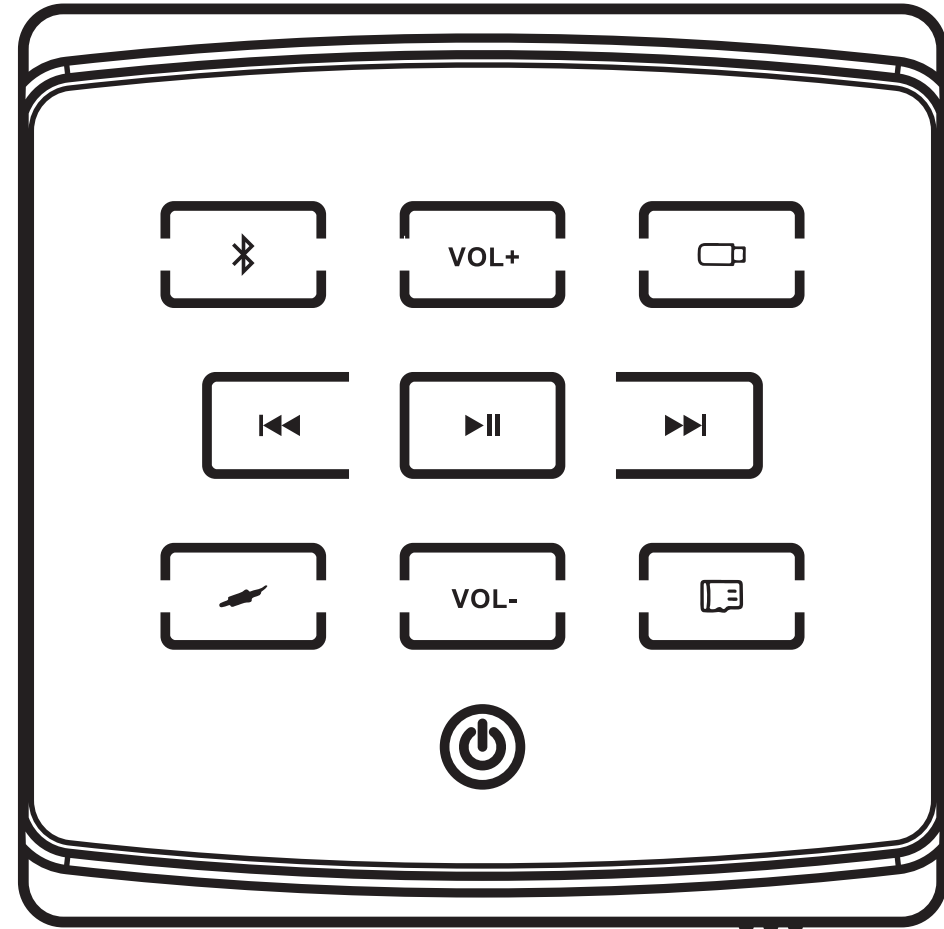

# INTEGRAL

## Front panel

- A Bluetooth mode: press to select Bluetooth input, long press to switch to 3D sound effect, displayed Bluetooth name would be BA-425D
- B Volume +
- C USB mode: press to select the USB mode, long press to switch the sound effect mode.
- D Previous song
- E Play/Pause
- F Next song
- G AUX mode / local line input (unbalanced)
- H Volume -
- I TF card mode

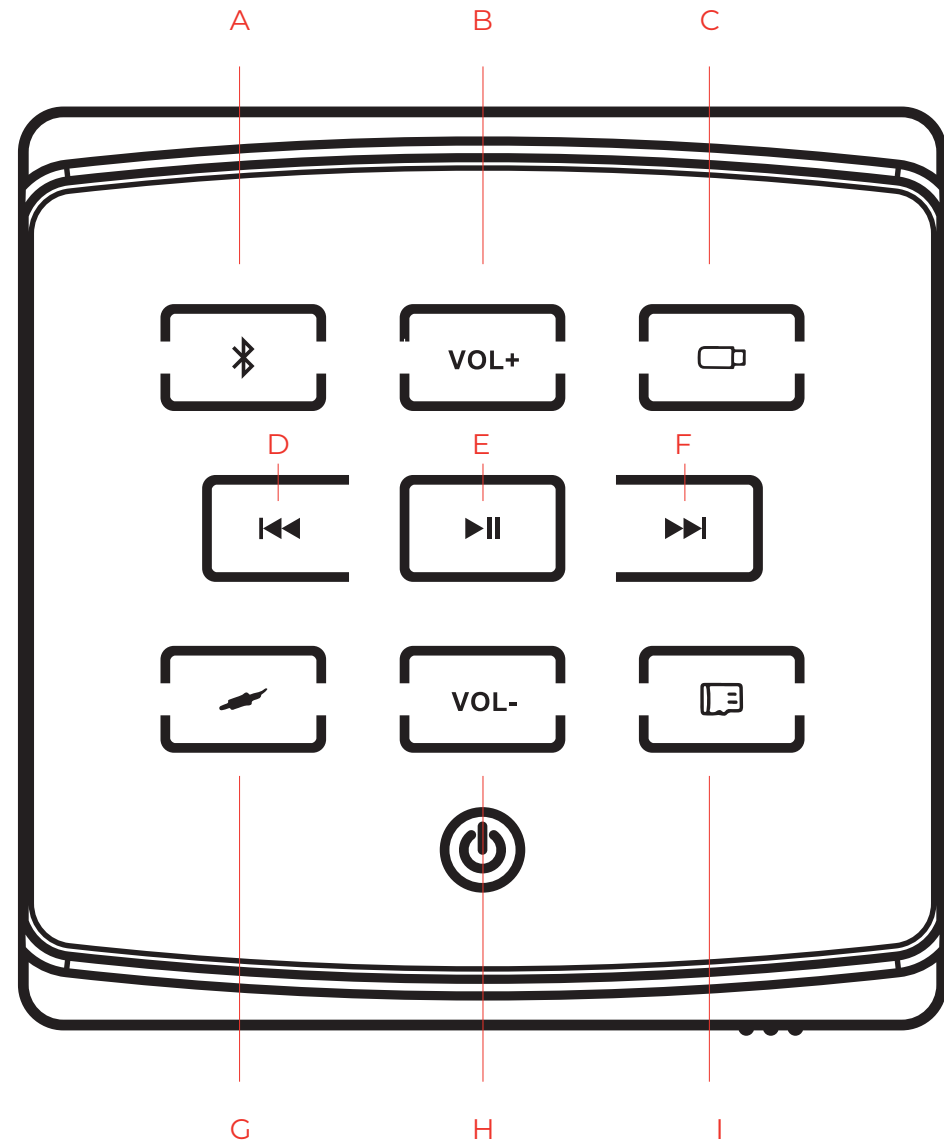

# INTEGRAL

## Bottom panel

All input and output connectors are terminal block type with 3.5mm pitch (connectors are provided with the units).

- A Speaker outputs: Right channel R+, R-
- B Speaker outputs: Left Channel L+, L-
- C Speaker outputs: Right channel R+, R-
- D Speaker outputs: Left Channel L+, L-
- E Line input: IN R+L+GND (unbalanced)
- F Line output: OUT R+L+GND (unbalanced)
- G Trigger alarm: Connect GND+IO
- H Doorbell trigger: DB+ GND
- I TF card insertion slot, maximum, 32GB
- J USB slot: can be connected to the standard 1.1, 2.0 USB, maximum 32G
- K Power ON/OFF Switch: Turn off the device to the left, turn on the device to the right
- L Power supply terminal: Universal Mains 115V-230V

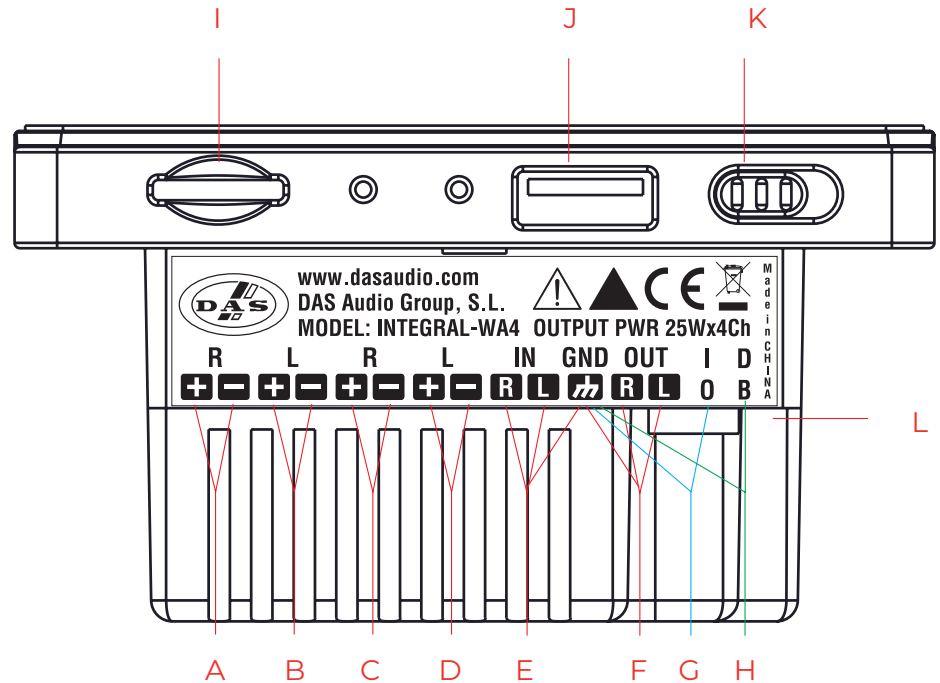

# INTEGRAL

## Remote control

- A Power on/off: press this button for 2 seconds to turn de device on or to shut it down
- B 3D sound effects
- C Volume control
- D Sound effect: Press this button to switch the sound effect
- E USB mode
- F Mute
- G Play/Pause button
- H Previous song/Next song
- I Local AUX Input
- J TF card mode
- K Bluetooth mode

*The remote control is powered by AAA bateries (not included in the product)*

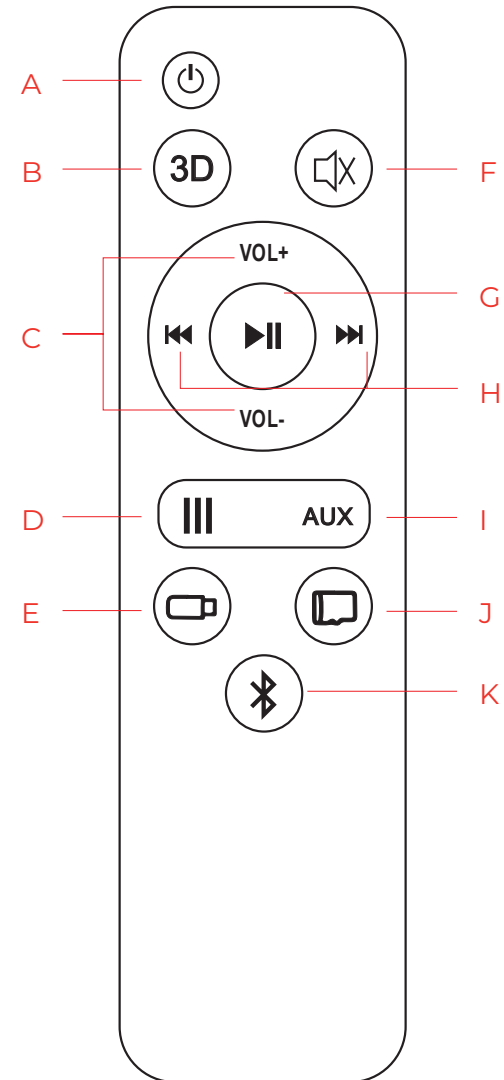

# INTEGRAL

## Connections

8ohm load per channel, BT audio input from a tablet or mobile phone

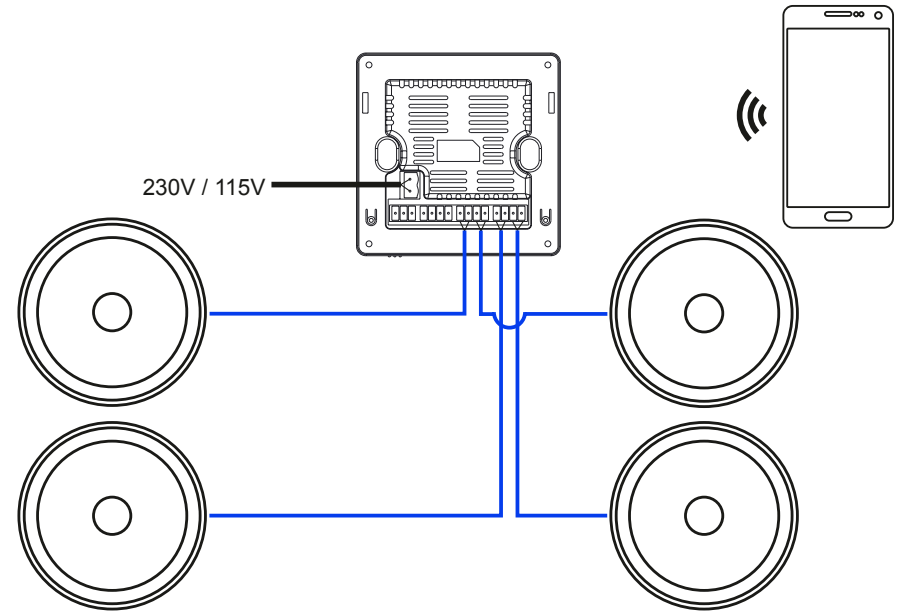

4ohm load per channel, BT audio input from a tablet or mobile phone

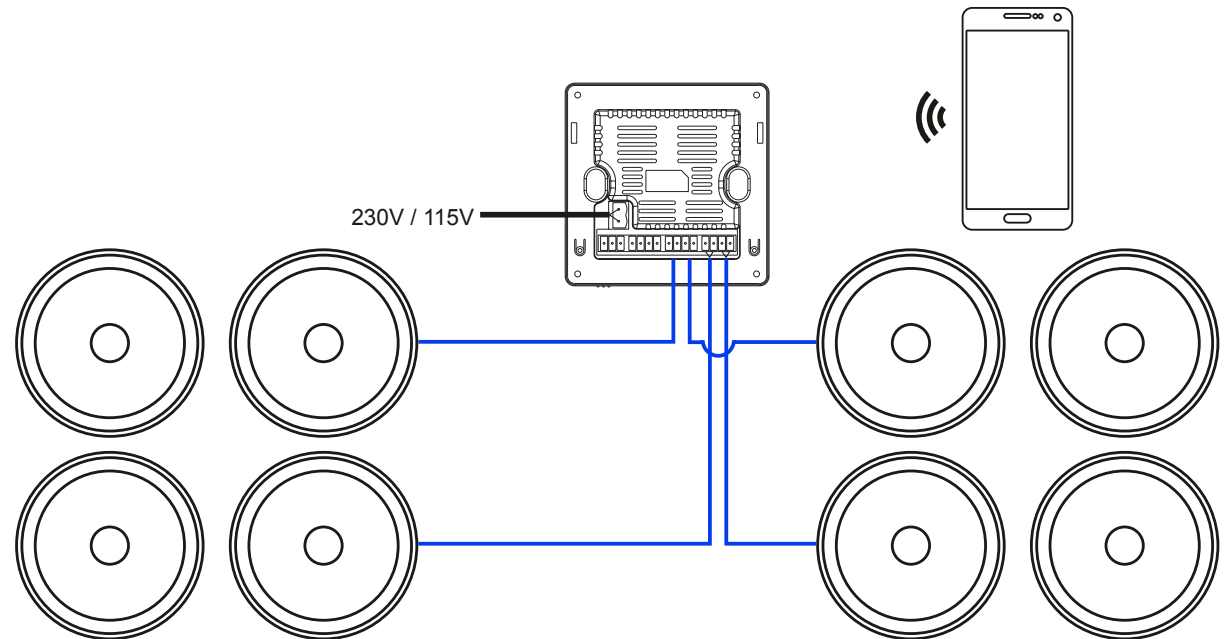

# INTEGRAL

## Connections

8ohm load per channel, BT audio input from a tablet or mobile phone and local analog input from an INTEGRAL-MA matrix amplifier model

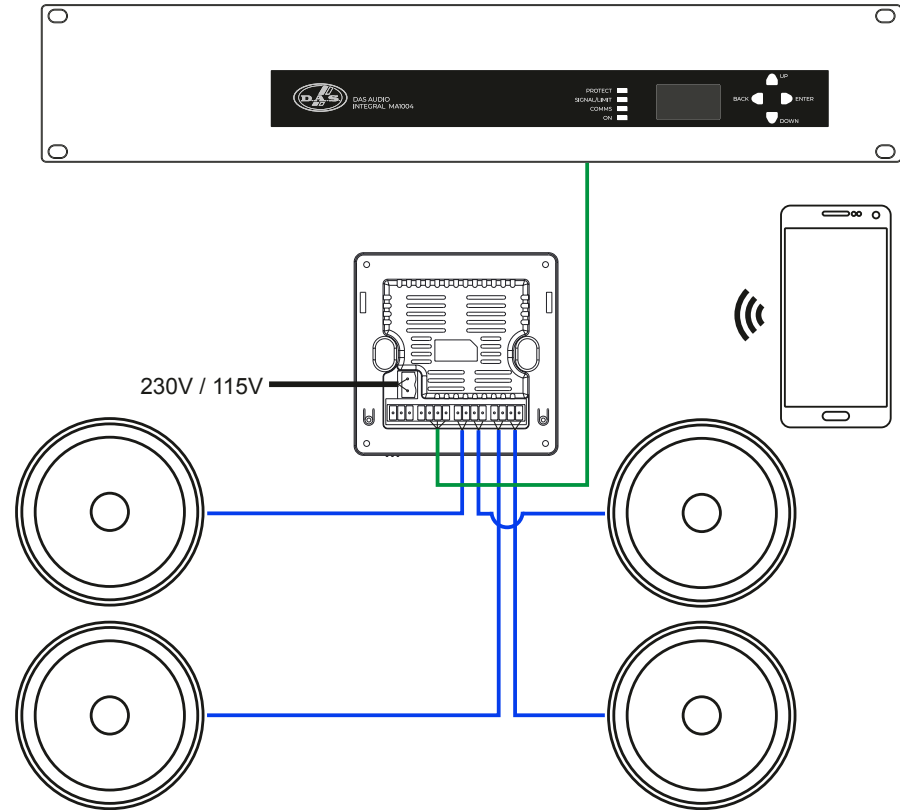



## INTEGRAL Installation

With each unit an electrical 86 x 86 mm box is included. Contact a professional installer or authorized dealer for the mounting process.

- Cut a squared hole in the wall to place the electrical box.
- Place the electrical box and fix it to the wall. Previously all cabling (speaker outputs, AC power and signal input) has been installed in the wall with sufficient length to provide proper stress relief.
- Run the cables out of the wall thru the electrical box.
- Attach the metal mounting ring to the electrical box with the provided screws.
- Mount the connectors on the extremes of the installed cabling.
- Connect the unit (speaker outputs, AC power etc.) and secure it to the mounting ring.

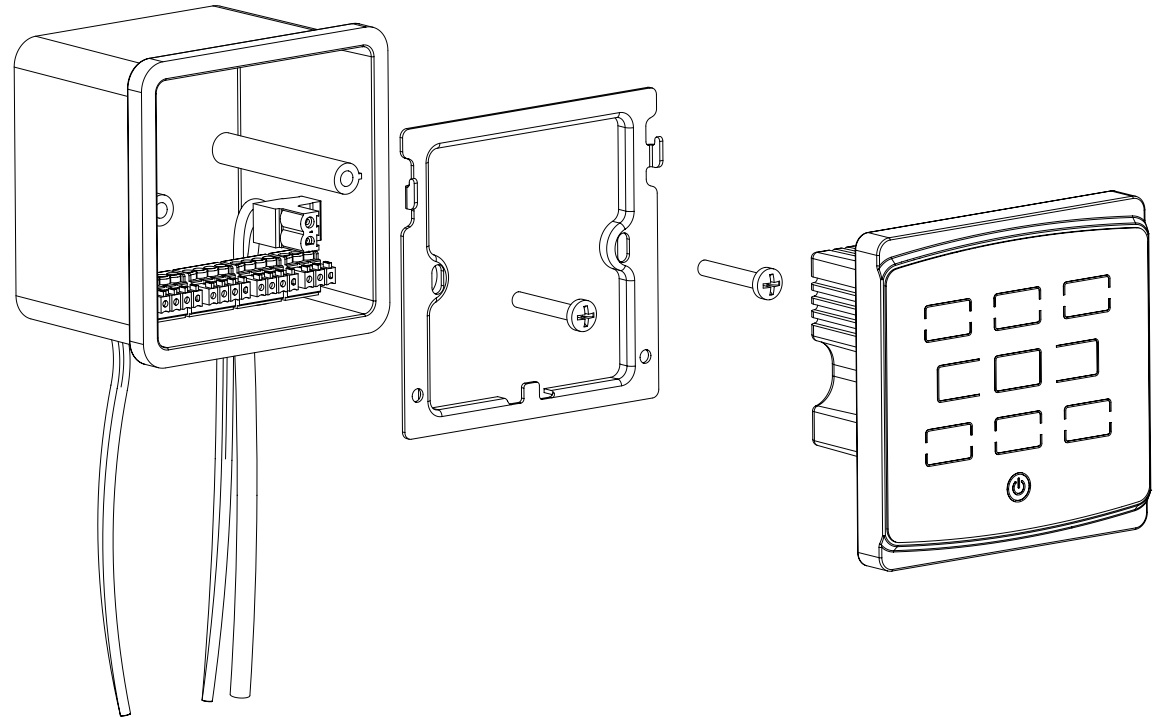

# INTEGRAL

## Use

All the main functions can be controlled using the front panel buttons. More options are available using the remote control. To switch on the unit, change the position (to the right) of the slide button located at the bottom. When using an external sound source (line input used), be sure to switch on this unit before the amplifier.

Once the amplifier has been switched on, select the audio source and start playing music. It is recommendable to start at low levels and increase volume if needed (volume can be adjusted in 20 different levels).

When setting the unit into standby mode (using the remote controller), it will restart by default reproducing the latest audio source before being switched off and keeping the same volume.

When switching off the unit from the bottom button, it won't keep the audio source previously selected. It will restart trying to find audio sources in this order:

- **Micro SD**
- **BT**
- **USB**

When connecting the unit via Bluetooth to a mobile device such a tablet or phone, the displayed name would be BA-425D. When the link between tablet or phone and the amplifier has been set, no other devices can be paired to the unit unless the device has lost the link (because of distance) or has been unpaired by the user.

# INTEGRAL

## Specifications

<b>Power 8 Ohms, Both Channels Driven</b>	4 x 12.5W
<b>Power 4 Ohms, Both Channels Driven</b>	4 x 25W
<b>Amplifier Channels</b>	4
<b>Output Circuitry</b>	Class D
<b>Frequency Response</b>	20Hz-20kHz, + - 2dB
<b>Sensitivity</b>	1.25V (+4dBu)
<b>Voltage Gain</b>	18dB
<b>Controls</b>	Push Buttons & Remote
<b>Amplifier Protections</b>	Short Circuit, DC Output
<b>Audio Signal input Connector</b>	Terminal Block
<b>Audio Signal output Connector</b>	Terminal Block
<b>AC Input Connector</b>	Terminal Block
<b>Operating Range</b>	90V – 250VAC
<b>Current Draw 230V</b>	0.6A
<b>Current Draw 115V</b>	1.2A
<b>Dimensions ( H x W x D )</b>	86 x 86 x 36 mm (3.38 x 3.38 x 1.4 in)
<b>Net Weight</b>	0.150 g

# INTEGRAL

## Line drawings

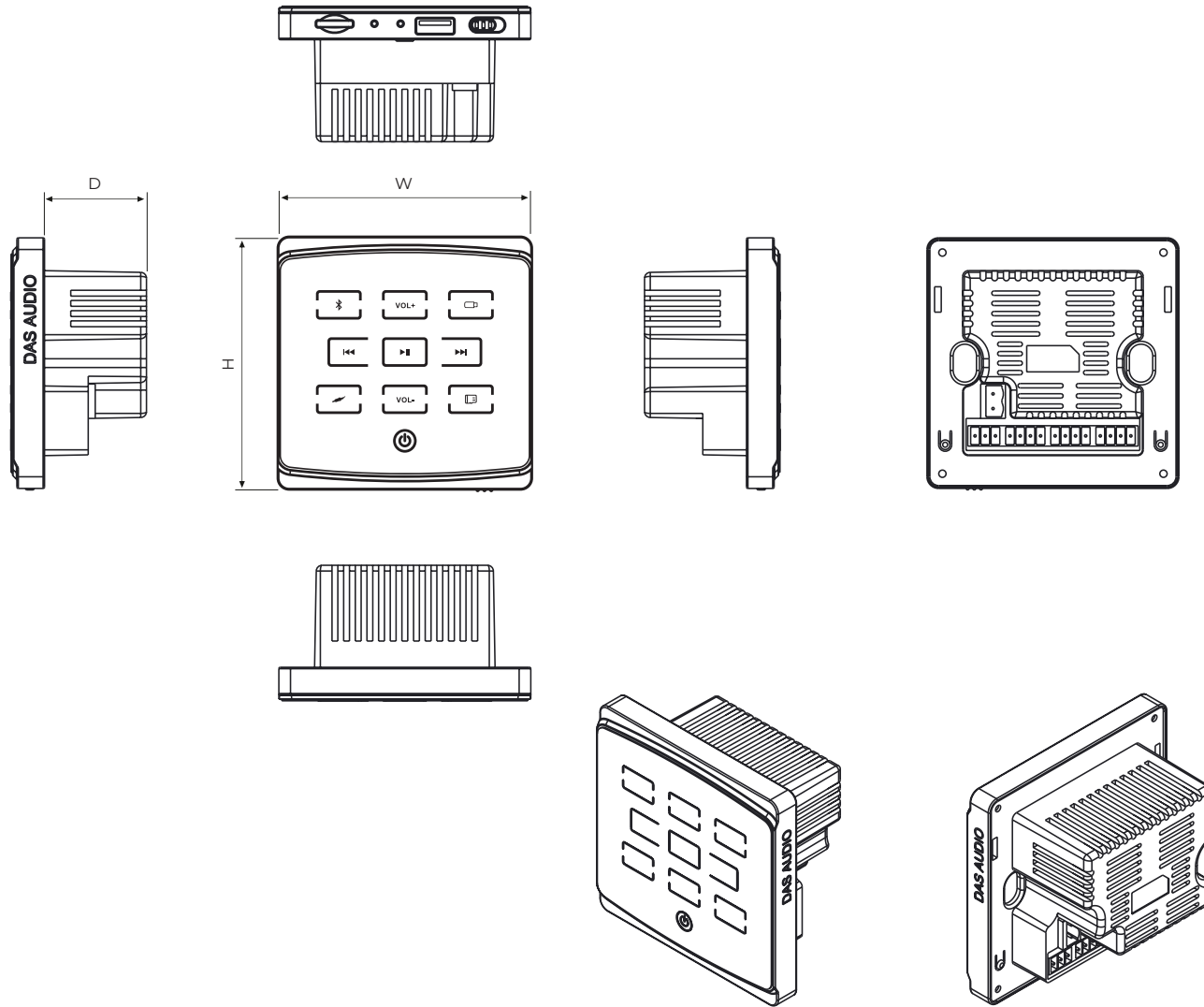

INTEGRAL  
**Notes**



SOUND WITH SOUL