



SYSTEM DIAGRAMS

FRAMEWORK AND CONCEPTS TO HELP BUILD LINE ARRAY SYSTEMS

WLA-28 System

A small stereo array with 4 x WLA-28's and 2 x 15" subs each side.

WLA-28's are connected using the In & Thru connectors in Passive mode.

Processing is handled by using 4 outputs of a single SC-26 Versadrive.

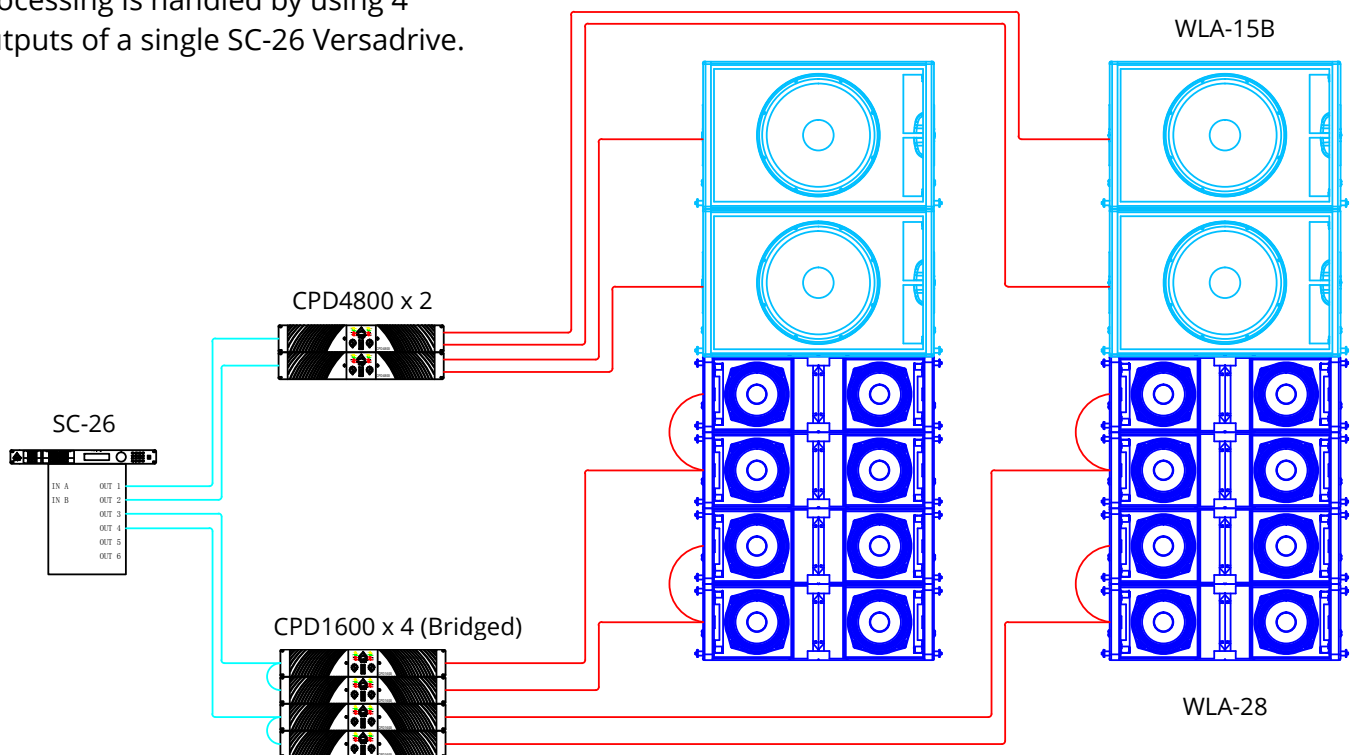

Product list

LOUDSPEAKERS	PROCESSING	AMPLIFIERS
WLA-28 x 8	SC-26	CPD1600 x 4
WLA-15B x 4		CPD4800 x 2



SYSTEM DIAGRAMS

FRAMEWORK AND CONCEPTS TO HELP BUILD LINE ARRAY SYSTEMS

WLA-28 System

A small stereo array with 4 x WLA-28's and 2 x 15" subs each side.

It uses the Bi-amp feature of the WLA-28s (Bi-amp mode).

Processing is handled by the 6 outputs of a single SC-26 Versadrive.

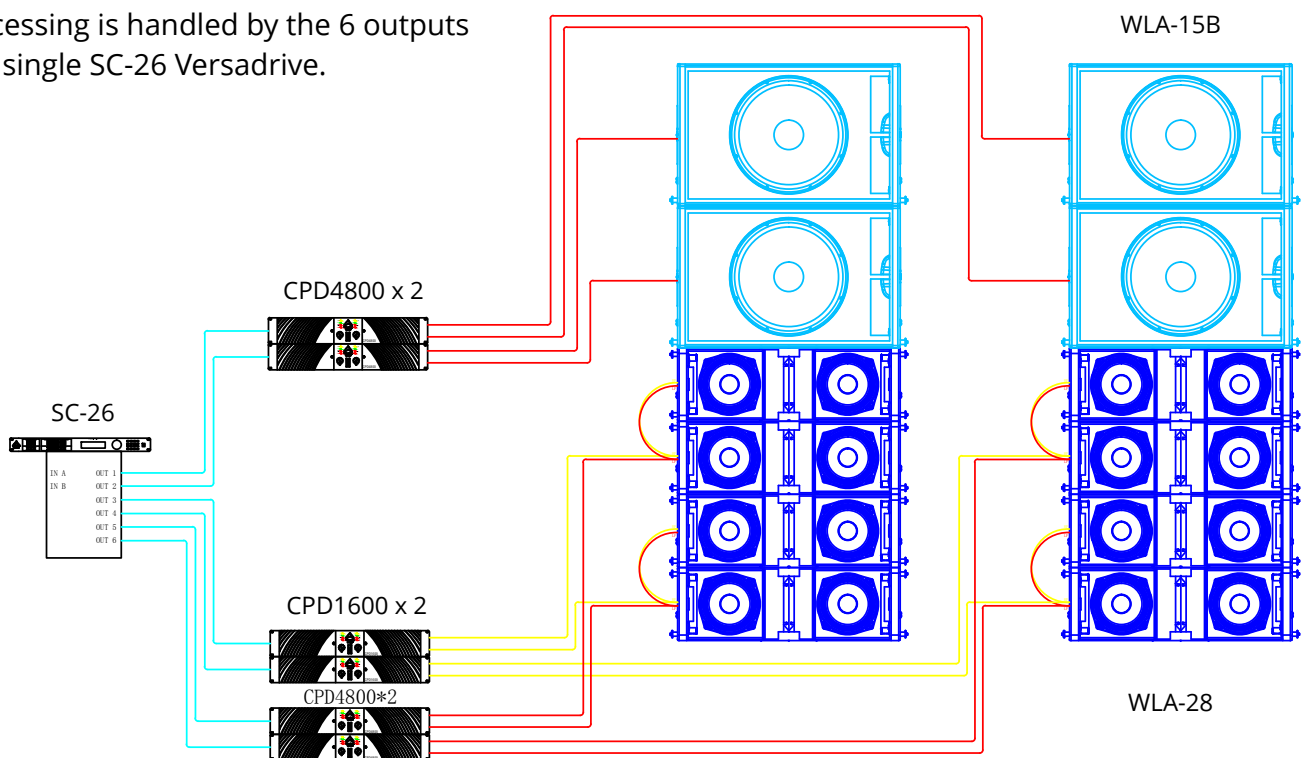
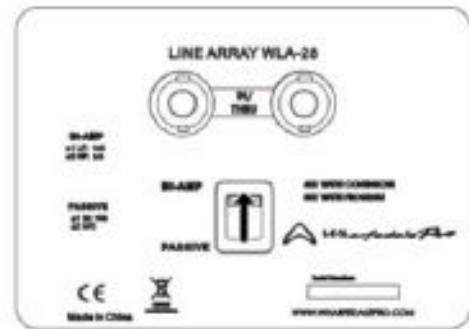

Product list

LOUDSPEAKERS	PROCESSING	AMPLIFIERS
WLA-28 x 8	SC-26	CPD1600 x 2
WLA-15B x 4		CPD4800 x 4



SYSTEM DIAGRAMS

FRAMEWORK AND CONCEPTS TO HELP BUILD LINE ARRAY SYSTEMS

WLA-28 System

A mid-sized stereo array with extra sub bass from 2 x Delta 218B's

There are 4 x WLA-28's and 2 x 15" subs each side.

WLA-28's are connected using the In & Thru connectors in Passive mode.

Note the use of the 'Link' connector on the CPD amps.

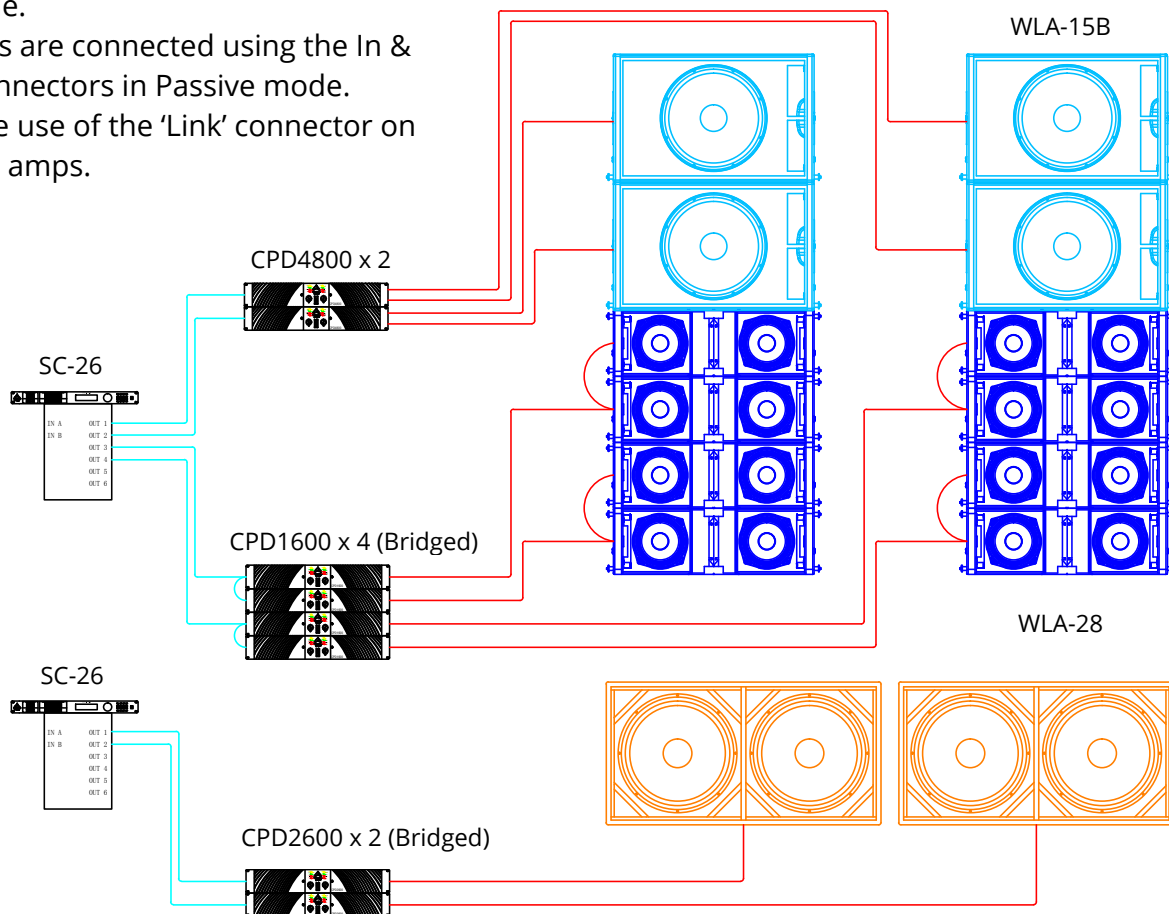

Product list

LOUDSPEAKERS	PROCESSING	AMPLIFIERS
WLA-28 x 8	SC-26 x 2	CPD1600 x 4
WLA-15B x 4		CPD4800 x 2
DELTA 218B x 2		CPD2600 x 2



SYSTEM DIAGRAMS

FRAMEWORK AND CONCEPTS TO HELP BUILD LINE ARRAY SYSTEMS

WLA-28 System

A large stereo array with extra sub bass from 4 x Delta 218B's
There are 8 x WLA-28's and 4 x 15" subs each side.

WLA-28's are connected using the In & Thru connectors in Passive mode.

Note the use of the 'Link' connector on the CPD amps.

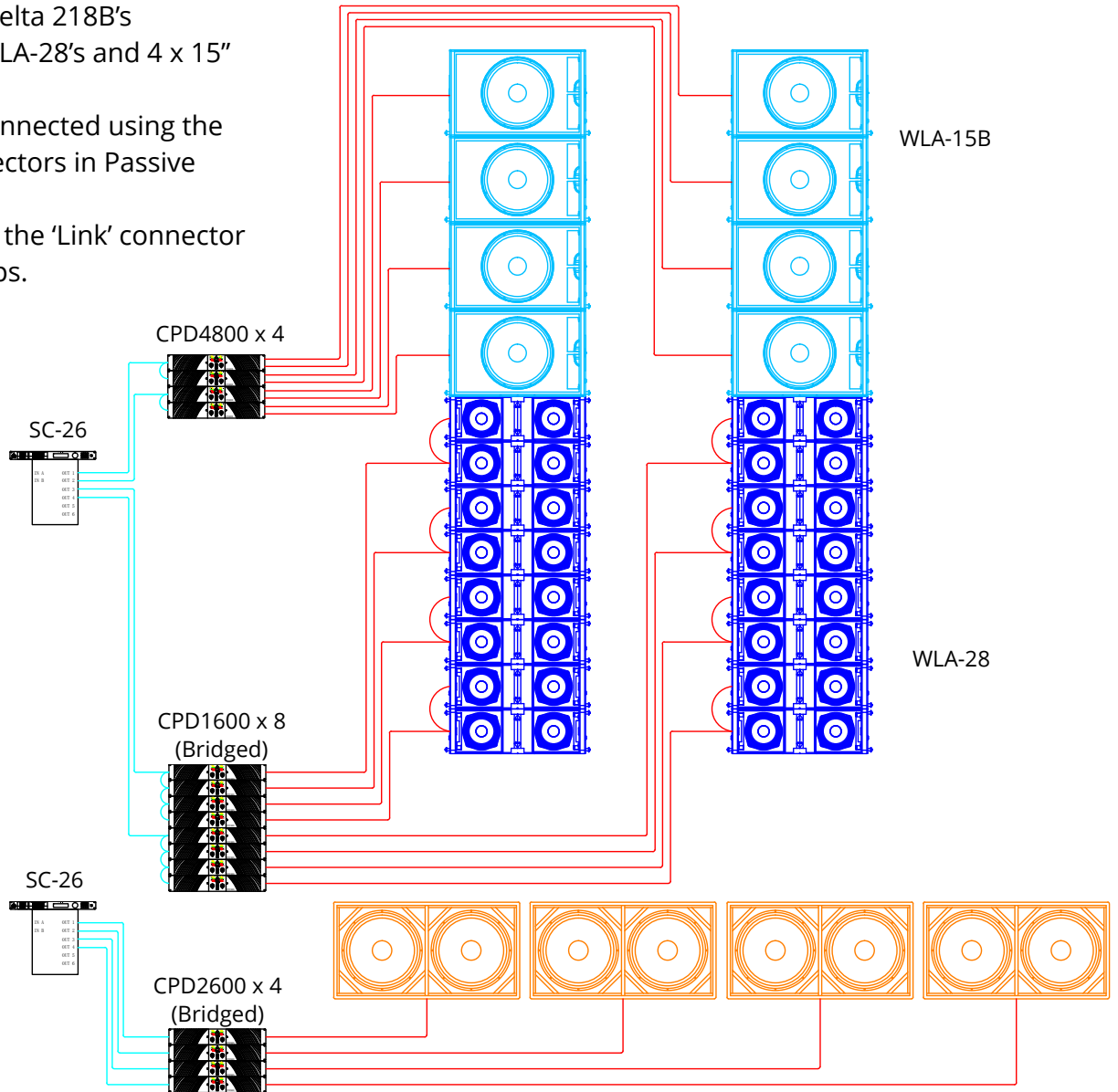

Product list

LOUDSPEAKERS	PROCESSING	AMPLIFIERS
WLA-28 x 16	SC-26 x 2	CPD1600 x 8
WLA-15B x 8		CPD4800 x 4
DELTA 218B x 4		CPD2600 x 4



SYSTEM DIAGRAMS

FRAMEWORK AND CONCEPTS TO HELP BUILD LINE ARRAY SYSTEMS

WLA-28 System

Using DP Series digital multi channel amplifiers, here is a lightweight and portable array system.

There are 4 x WLA-28, a dual 15" sub and 2 x 18" subs each side.

WLA-28's are connected using the In & Thru connectors in Passive mode.

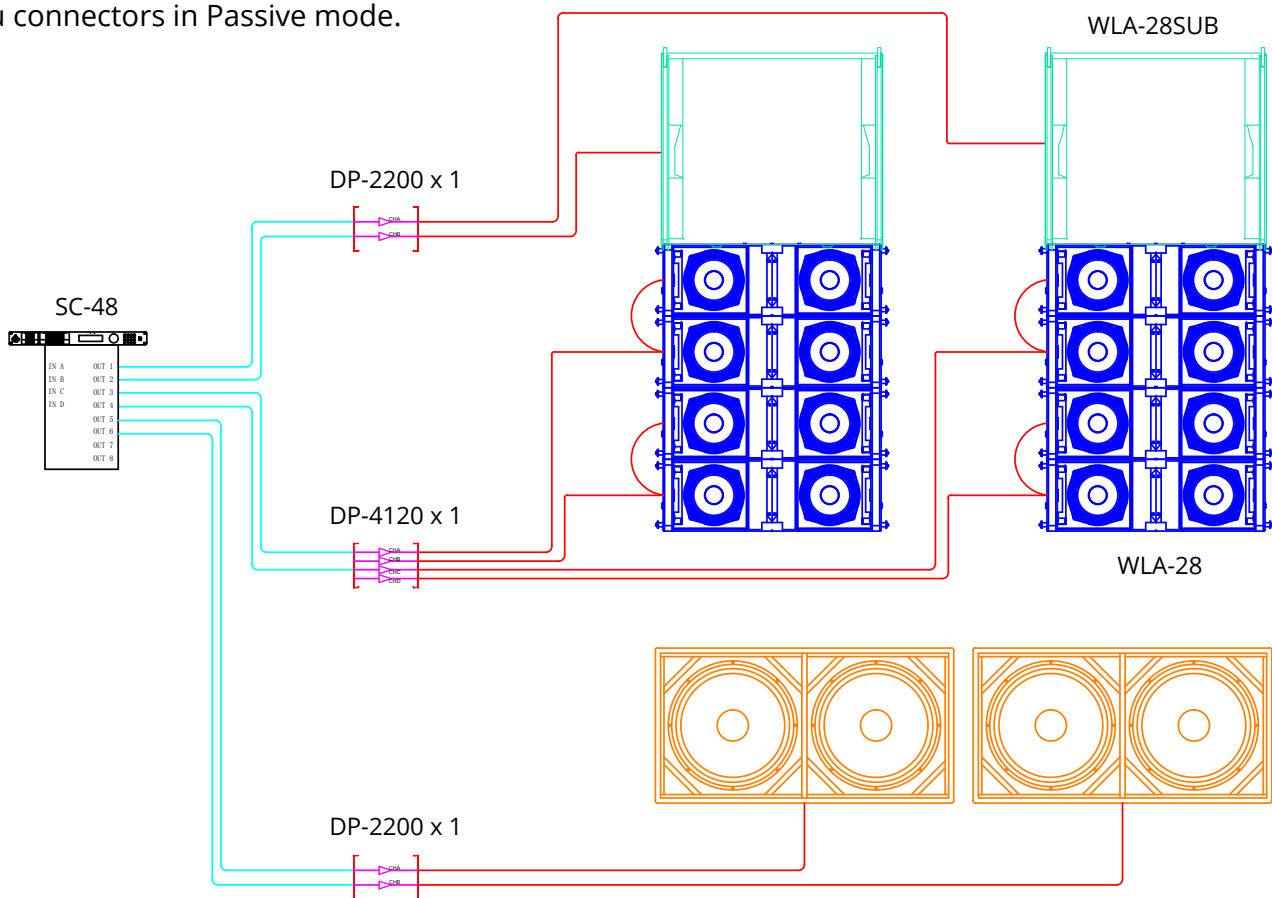

Product list

LOUDSPEAKERS	PROCESSING	AMPLIFIERS
WLA-28 x 8	SC-48	DP-2200 x 2
WLA-28SUB x 2		DP-4120
DELTA 218B x 2		



SYSTEM DIAGRAMS

FRAMEWORK AND CONCEPTS TO HELP BUILD LINE ARRAY SYSTEMS

WLA-28 System

This large system uses 6 x DP Series digital multi channel amplifiers. There are 8 x WLA-28, 2 x dual 15" subs and 4 x 18" subs each side. WLA-28's are connected using the In & Thru connectors in Passive mode. All processing is handled by a single SC-48 Versadrive.

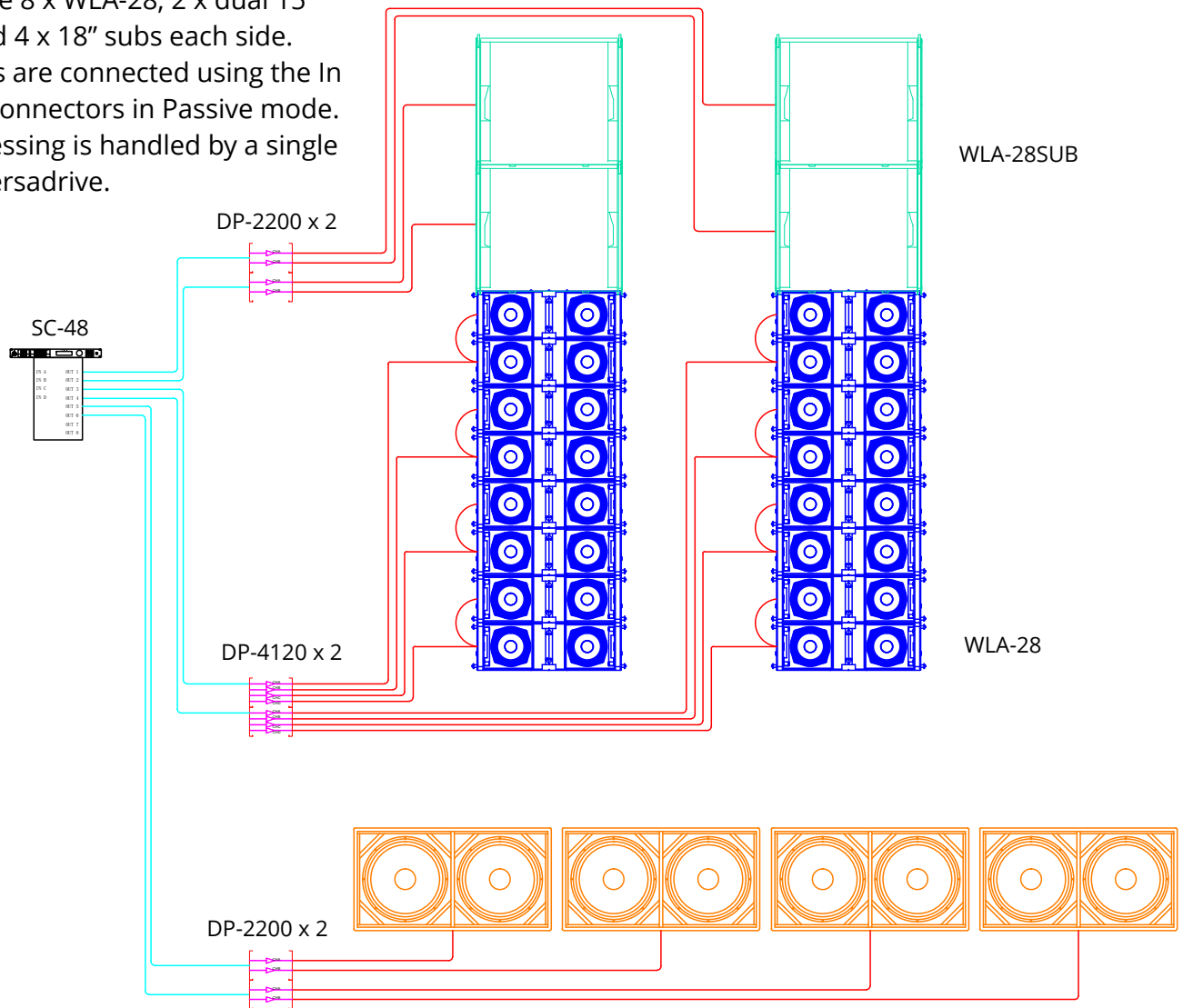

Product list

LOUDSPEAKERS	PROCESSING	AMPLIFIERS
WLA-28 x 16	SC-48	DP-2200 x 4
WLA-28SUB x 4		DP-4120 x 2
DELTA 218B x 4		