

PROFESSIONAL SOUND SYSTEMS >>>

# SIGMA Series

## OPERATING MANUAL AND USER GUIDE

SIGMA-8 SIGMA-10 SIGMA-12 SIGMA-15 SIGMA-18B SIGMA-V4 SIGMA-V8

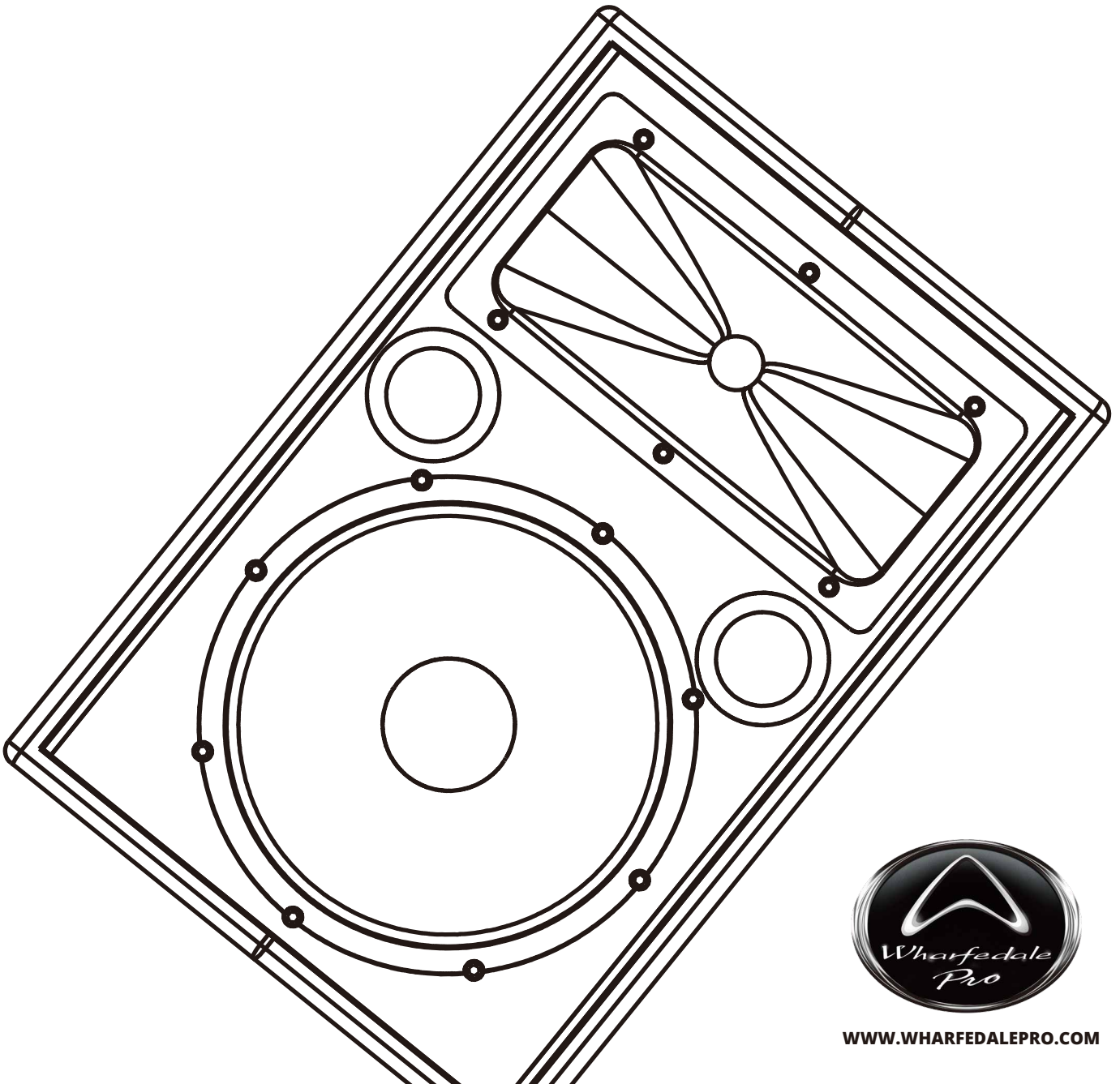

WWW.WHARFEDELEPRO.COM

# TABLE OF CONTENTS

- IMPORTANT WARNINGS & SAFETY INSTRUCTIONS..... 1
- SIGMA SERIES INTRODUCTION ..... 2
- KEY FEATURES ..... 2
- INSTALLATION ..... 2
- CONNECTIONS / WIRING ..... 3
- RIGGING / SUSPENDING ..... 4
- DIMENSIONAL DRAWINGS..... 5
- SPECIFICATIONS ..... 8
- WARRANTY..... 9

# IMPORTANT WARNINGS & SAFETY INSTRUCTIONS

- **READ ALL INSTRUCTIONS** - Become familiar with the features and functions of these products before operating them.
- **COMPLY WITH ALL WARNINGS** - All warnings and instructions for this product should be adhered to.
- **USE WITH AMPLIFIERS** - In order to avoid damage to drivers and other equipment, it is advisable to establish and follow a routine for powering up and powering down a sound system. With all system components connected, turn on source equipment (mixers, signal processors, record and playback units, etc.) **BEFORE** powering up amplifiers. Transient voltages from powering up source equipment can damage speakers if amplifiers are already turned on. Make sure that amplifier volumes are set to their minimum settings and power up any system amplifiers **LAST**. It is recommended that all system components be allowed to stabilize for several seconds before any source signals are introduced or level setting adjustments are made. Similarly, when shutting systems down, turn all amplifiers off first, before powering down any other system components.
- **CABLES** - Do not use shielded or microphone cable for connection between amplifiers and speakers. Use only approved speaker cables with proper connectors.
- **RIGGING, SUSPENDING, AND MOUNTING** - Suspending and mounting of these speaker systems can expose members of the public to serious health risks and even death.

Under no circumstances attempt to rig, suspend or otherwise mount these speakers unless you are fully qualified and certified to do so by relevant local, state and national authorities. All relevant safety regulations must be followed. If you are not properly qualified or do not know of pertinent regulations, consult qualified personnel for advice.

- **CAUTION** - These professional loudspeaker systems are capable of generating very high sound pressure levels. Use care with placement and operation to avoid exposure to excessive volume levels. Permanent hearing damage can result when operated to extreme levels.
- **SERVICE**-There are no user serviceable parts inside this product. Users should not attempt to service this product. Warranty nullification could result if this is attempted.

# INTRODUCTION

Wharfedale Pro SIGMA Series are extreme power handling, ultra hardwearing loudspeakers in an affordable package built for a multitude of live sound applications. Our latest developments in loudspeaker technology harness dual voice coil woofers reaching depths of 35Hz. These proprietary LF drivers are paired with 1.75" Titanium Tweeters which throw high end to your crowd, while crossover points and acoustic characteristics are tuned by our experienced engineers for sonic accuracy. The cabinets adapt to multiple formations – M8 rigging points, dual angle speaker poles and carry handles meet the varying demands of fixed installation and touring with our Rhino Rock finish and steel grilles providing protection for a lifetime of use.

## KEY FEATURES

Very High SPL Output Capability

High Sensitivity & Dynamic Range

Custom 90 x 60 HF Waveguides

Custom High Output, Low Distortion Woofers

Custom Compression Drivers

Dual layer Voice Coils (Quad layer on SIGMA 18B)

Proprietary Rhino Rock Painted Enclosure

HF Protection Circuitry

Parallel Wired speakon Inputs

Dual Angle Pole Mount Receptacles (Excludes SIGMA 8)

## INSTALLATION

Before attempting to install a SIGMA Series Loudspeaker system please refer to the important warnings and safety instructions. Only qualified personnel should install a loudspeaker system.

Improper installation of a loudspeaker system can cause serious harm and even death if correct procedure is not followed. Anyone attempting installation assumes all liability arising from such use.

Speakers with dual angle pole mount sockets (SIGMA 10 / 12 / 15) have an sockets that angles the cabinet down by 10°. This allows more sound to be aimed directly at the audience and less at the ceiling, reducing early reflections. Please ensure that the correct socket is used for each speaker.

# CONNECTIONS/WIRING

Connecting the SIGMA Series to your system is easy. The input panel includes parallel Speakon connectors. Run your speaker wires from your amplifier to the speaker - you can use either input connector. Use the correct gauge of stranded insulated speaker cable according to the power handling ability of your SIGMA Series cabinet. It is always advisable to use heavier gauge (lower number) cables on longer runs. Be sure to connect your speakers in proper polarity (what many refer to erroneously, as phase). This means that in normal operation, connect one end of the same wire to the + or Red terminal on the amplifier and the other end to the +1 on the NL4 Connector. The other wire is connected to the -1 pin on the NL4 CONNECTOR. Be sure to use high quality, low gauge (thick) speaker wire and NOT shielded cable.

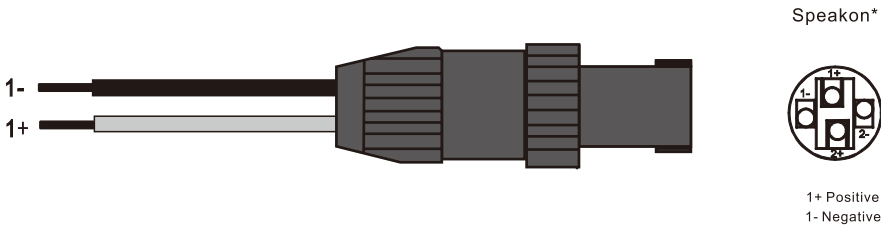

## SIGMA SERIES CONNECTION PANELS

The SIGMA Series loudspeakers feature parallel wire inputs. Either input can be used for a simple system and 2 speakers can be parallel wired using a standard speaker cable. When Parallel wiring loudspeakers always take in consideration the load you are putting on your amplifier. 2 parallel wired SIGMA loudspeakers will produce a 4 ohm load.

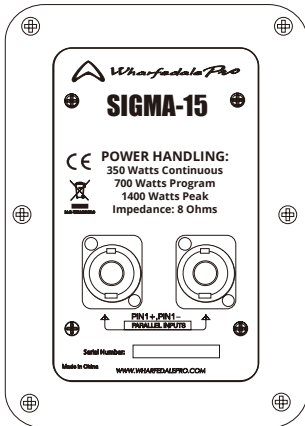

SIGMA-8/10/12/15 Rear Panel

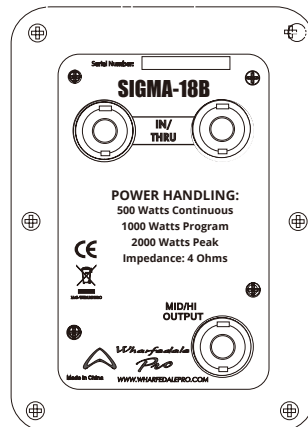

SIGMA-18B Rear Panel

## IMPORTANT NOTE

To avoid any possible damage to your amp and speakers, be sure to check the owner's manual of your power amplifier to confirm it is capable of operating at 2 ohms. The SIGMA 18B has a High Pass output. The high pass allows you to connect a full range SIGMA loudspeaker and subwoofer to one amplifier channel with 4 ohm load

# RIGGING/SUSPENDING

All full range SIGMA enclosures (except SIGMA-18B) include multiple M8 rigging points for fast, safe and secure suspension.

## Using Shoulder Eyebolts

Always apply the load to the bolt along the plane of the eye. For long term installation use a thread-locking compound. Do not attempt to bend or otherwise deform any rigging hardware.

**Please refer to the important safety warnings before you consider suspending any loudspeakers.**

Each primary load bearing suspension point shall be rated for the total load.

(A minimum 5:1 Design Factor)

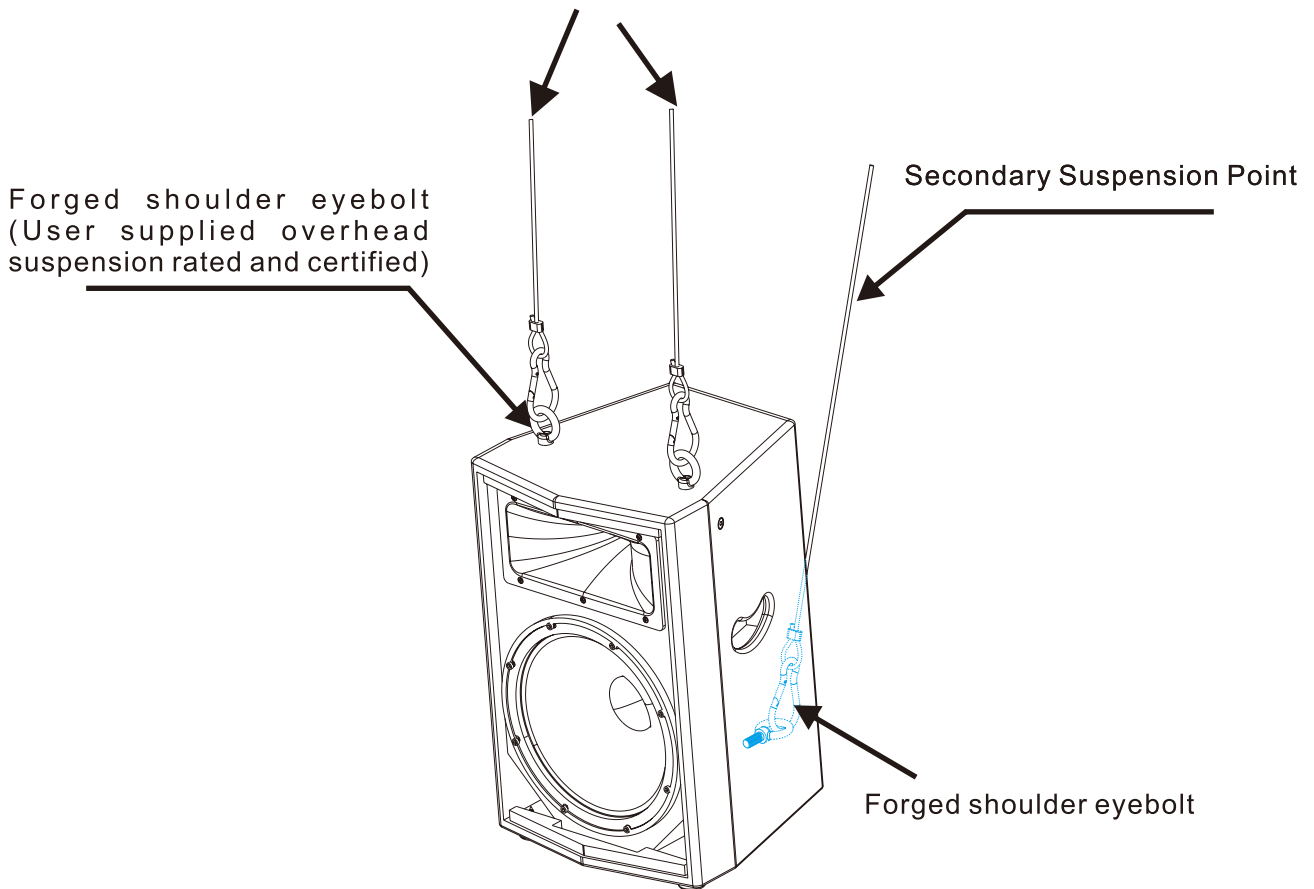

Working load limits: NO more than four(4)high(vertical)  
The four(4)high vertical specification represents a static ratio of 7:1

# DIMENSIONAL DRAWINGS

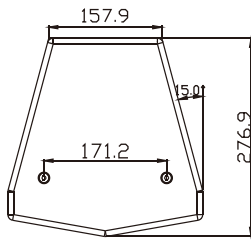

TOP VIEW

SIGMA-8

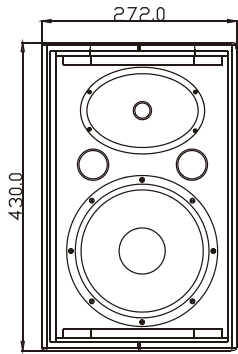

FRONT VIEW

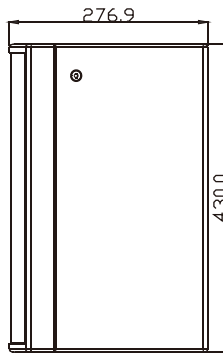

SIDE VIEW

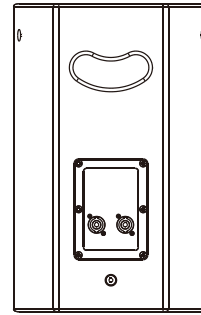

REAR VIEW

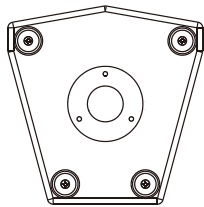

BOTTOM VIEW

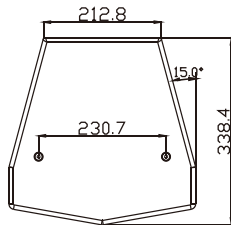

TOP VIEW

SIGMA-10

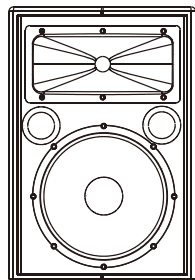

FRONT VIEW

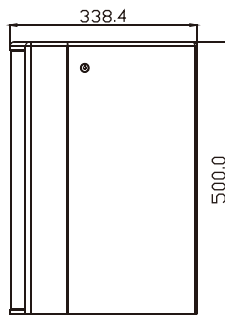

SIDE VIEW

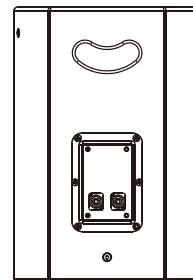

REAR VIEW

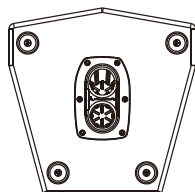

BOTTOM VIEW

# DIMENSIONAL DRAWINGS

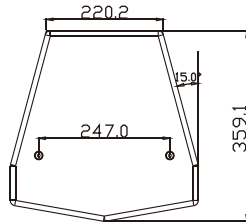

TOP VIEW

SIGMA-12

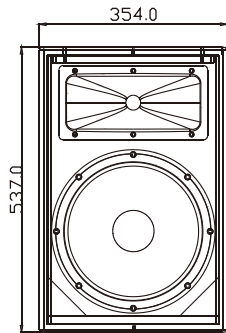

FRONT VIEW

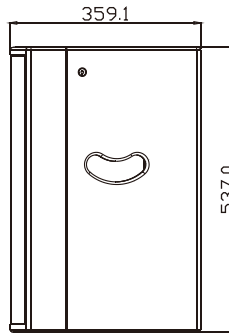

SIDE VIEW

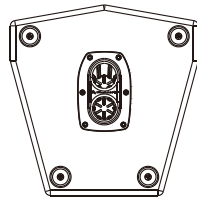
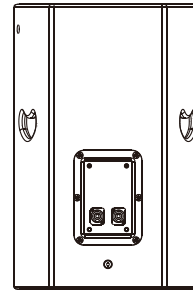

BOTTOM VIEW

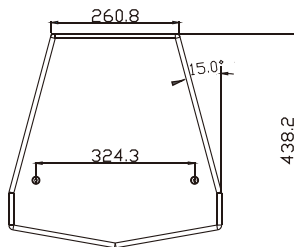

TOP VIEW

SIGMA-15

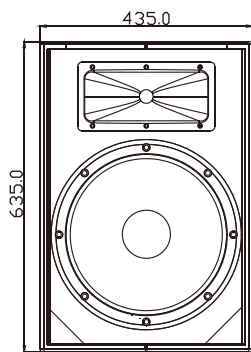

FRONT VIEW

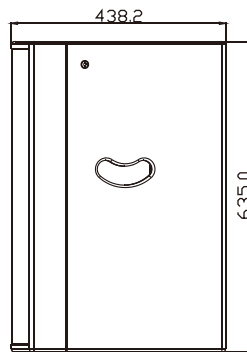

SIDE VIEW

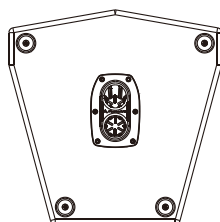
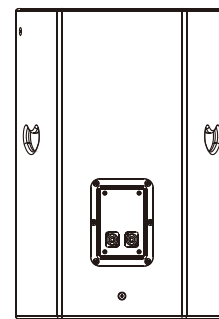

BOTTOM VIEW



# DIMENSIONAL DRAWINGS

SIGMA-18B

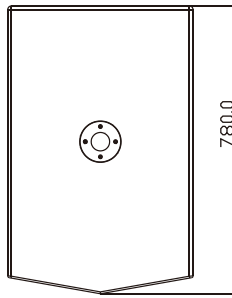

TOP VIEW

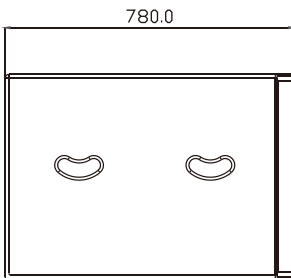

SIDE VIEW

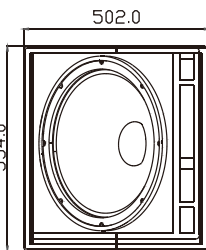

FRONT VIEW

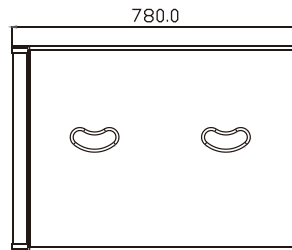

SIDE VIEW

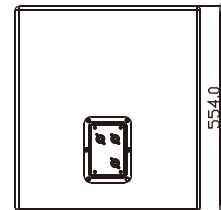

REAR VIEW

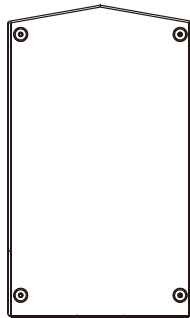

BOTTOM VIEW

# DIMENSIONAL DRAWINGS

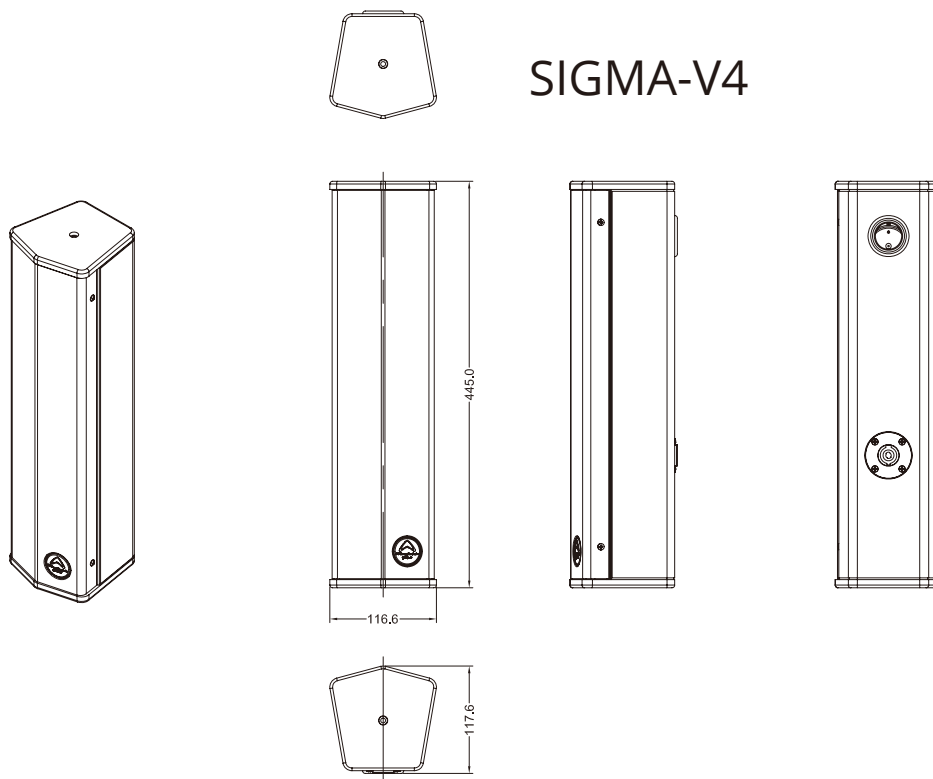

SIGMA-V4

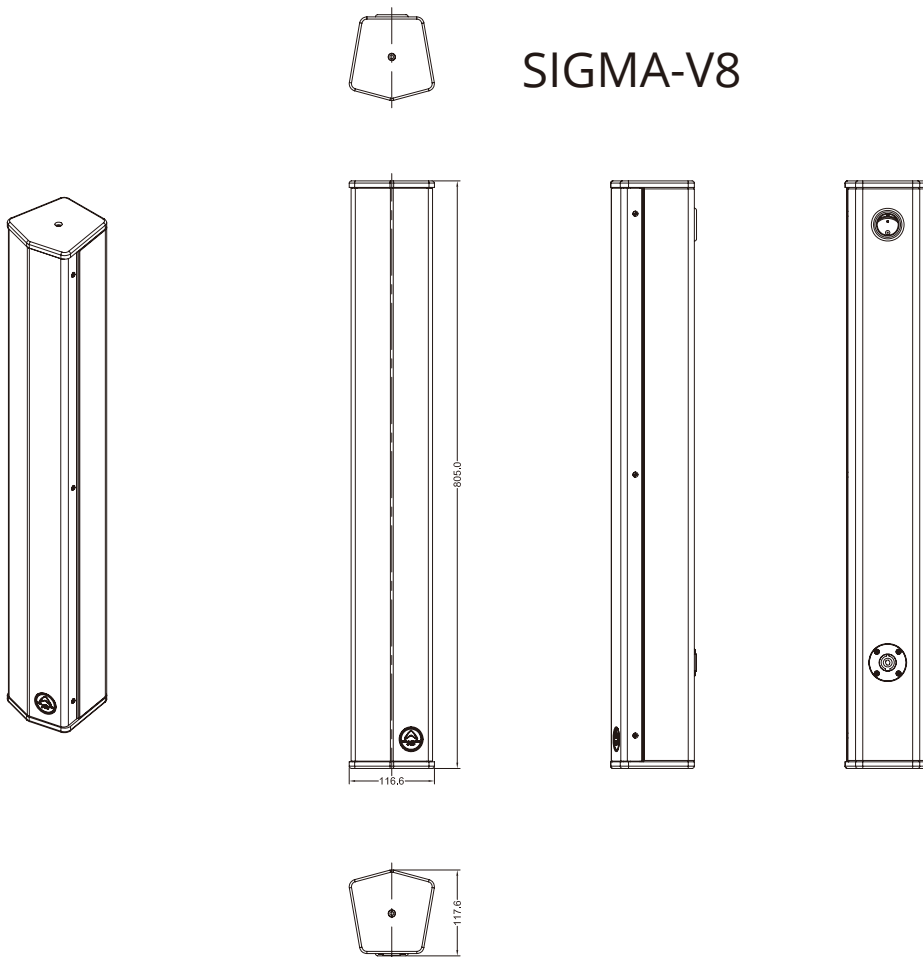

SIGMA-V8

# SPECIFICATIONS

<b>Model Name</b>	<b>SIGMA-8</b>	<b>SIGMA-10</b>
System Type	Passive	Passive
Configuration	Two-way	Two-way
Frequency Response (+/-3 dB)	70 Hz - 18 kHz	65 Hz - 18 kHz
Frequency Range (- 10 dB)	65 Hz - 20 kHz	60 Hz - 20 kHz
Sensitivity (2.83 v / 1 m)	96 dB	97 dB
Calculated Maximum SPL @1 m	124 dB	126 dB
System Rated Impedance	8 Ω	8 Ω
<b>Low Frequency Transducer</b>		
Size (mm / inches)	203 mm / 8"	254 mm / 10"
Voice Coil Size (mm / inches)	38 mm / 1.5"	38 mm / 1.5"
Rated Impedance	8 Ω	8 Ω
LF Power (re:AES2-2012)	150 W	200 W
<b>High Frequency Transducer</b>		
HF Driver Type	Compression Driver	Compression Driver
Coil Size (mm / inches)	25 mm / 1"	44 mm / 1.75"
Exit Size (mm / inches)	1"	1"
Diaphragm Material	Polymer	Titanium
Rated Impedance	8 Ω	8 Ω
HF Power (re:AES2-2012)	25 W	40 W
Nominal Coverage (H x V)	90° x 60°	90° x 60°
<b>Power</b>		
System Continuous Power	150 W	200 W
System Programme Power	300 W	400 W
System Peak Power	600 W	800 W
Crossover frequency	2.8 kHz	2.4 kHz
Input Connector	2 x NL4 (speakON compatible)	2 x NL4 (speakON compatible)
Hardware:	35 mm pole socket M8 x 5 1 Handle on back	Dual-angle (0° or 10°) 35 mm pole socket M8 x 5 1 Handle on back
<b>Enclosure</b>		
Enclosure Material	12 mm MDF	15 mm MDF
Finish	Black Paint / White Paint	Black Paint / White Paint
Grille Material & Finish	1.2 mm steel, painted	1.2 mm steel, painted
<b>Dimensions - Unpacked</b>		
Height	430 mm / 17"	500 mm / 19.5"
Width Front	272 mm / 11"	383 mm / 13.3"
Width Rear	158 mm / 6"	213 mm / 8.4"
Depth	277 mm / 13.5"	339 mm / 13.3"
<b>Dimensions - Packed</b>		
Height	505 mm / 20"	585 mm / 23"
Width Front	363 mm / 14.25"	451 mm / 18"
Width Rear	196 mm / 7.71"	254 mm / 10"
Depth	322 mm / 12.75"	384 mm / 13.3"
Net Weight	7.8 kg / 17 lbs	15.4 kg / 34 lbs
Gross Weight	8.8 kg / 19 lbs	17.8 kg / 38.5 lbs

# SPECIFICATIONS

<b>Model Name</b>	<b>SIGMA-12</b>	<b>SIGMA-15</b>
System Type	Passive	Passive
Configuration	Two-way	Two-way
Frequency Response (+/-3 dB)	60 Hz - 18 kHz	50 Hz - 18 kHz
Frequency Range (- 10 dB)	55 Hz - 20 kHz	45 Hz - 20 kHz
Sensitivity (2.83 v / 1 m)	98 dB	98 dB
Calculated Maximum SPL @1 m	129 dB	129 dB
System Rated Impedance	8 Ω	8 Ω
<b>Low Frequency Transducer</b>		
Size (mm / inches)	305 mm / 12"	381 mm / 15"
Voice Coil Size (mm / inches)	64 mm / 2.5"	64 mm / 2.5"
Rated Impedance	8 Ω	8 Ω
LF Power (re:AES2-2012)	300 W	350 W
<b>High Frequency Transducer</b>		
HF Driver Type	Compression Driver	Compression Driver
Coil Size (mm / inches)	44 mm / 1.75"	44 mm / 1.75"
Exit Size (mm / inches)	1"	1"
Diaphragm Material	Titanium	Titanium
Rated Impedance	8 Ω	8 Ω
HF Power (re:AES2-2012)	40 W	40 W
Nominal Coverage (H x V)	90° x 60°	90° x 60°
<b>Power</b>		
System Continuous Power	300 W	350 W
System Programme Power	600 W	700 W
System Peak Power	1200 W	1400 W
Crossover frequency	2.2 kHz	2.2 kHz
Input Connector	2 x NL4 (speakON compatible)	2 x NL4 (speakON compatible)
Hardware:	Dual-angle (0° or 10°) 35 mm pole socket M8 x 5 2 Handles on side	Dual-angle (0° or 10°) 35 mm pole socket M8 x 5 2 Handles on side
<b>Enclosure</b>		
Enclosure Material	15 mm MDF	15 mm MDF
Finish	Black Paint / White Paint	Black Paint / White Paint
Grille Material & Finish	1.2 mm steel, painted	1.2 mm steel, painted
<b>Dimensions - Unpacked</b>		
Height	537 mm / 21"	635 mm / 25"
Width Front	354 mm / 14"	435 mm / 17"
Width Rear	218 mm / 8"	261 mm / 11.7"
Depth	359 mm / 14"	439 mm / 17.25"
<b>Dimensions - Packed</b>		
Height	625 mm / 24.6"	720 mm / 28.35"
Width Front	468 mm / 18.4"	553 mm / 21.75"
Width Rear	260 mm / 10.2"	303 mm / 12"
Depth	404 mm / 15.9"	488 mm / 19.2"
Net Weight	18.2 kg / 40 lbs	23.4 kg / 51.5 lbs
Gross Weight	20.9 kg / 45 lbs	26.7 kg / 58.7 lbs

# SPECIFICATIONS

<b>Model Name</b>	<b>SIGMA-18B</b>	<b>SIGMA-V4</b>	<b>SIGMA-V8</b>
System Type	Passive	Passive	Passive
Configuration	subwoofer	Full Range	Full Range
Frequency Response (+/-3 dB)	35 Hz-250 HZ	160 Hz - 17 KHz	130 Hz - 17 KHz
Frequency Range (- 10 dB)	30 Hz-250 HZ	150 Hz - 20 KHz	120 Hz - 20 KHz
Sensitivity (2.83 v / 1 m)	100 dB	95 dB	97 dB
Calculated Maximum SPL @1 m	133 dB	123 dB	128 dB
System Rated Impedance	4 Ω	8 Ω	8 Ω
<b>Low Frequency Transducer</b>			
Size (mm / inches)	457 mm / 18"	4 x 75 mm / 3"	8 x 75 mm / 3"
Voice Coil Size (mm / inches)	64 mm / 2.5"	33 mm / 1.3"	33 mm / 1.3"
Rated Impedance	4 Ω	8 Ω	4 Ω
LF Power (re:AES2-2012)	500 W	40 W	40 W
<b>High Frequency Transducer</b>			
HF Driver Type	na	na	na
Coil Size (mm / inches)	na	na	na
Exit Size (mm / inches)	na	na	na
Diaphragm Material	na	na	na
Rated Impedance	na	na	na
HF Power (re:AES2-2012)	na	na	na
Nominal Coverage (H x V)	na	160° x 40°	160° x 30°
<b>Power</b>			
System Continuous Power	500 W	150 W	300 W
System Programme Power	1000 W	300 W	600 W
System Peak Power	2000 W	600 W	1200 W
Crossover frequency	150 Hz	na	na
Input Connector	2 x NL4 (speakON compatible)	1 x NL4 (speakON compatible)	1 x NL4 (speakON compatible)
Hi Pass output connector	1 x NL4 (speakON compatible)		
Hardware:	35 mm pole socket 4 Handles on sides	Bracket	Bracket
<b>Enclosure</b>			
Enclosure Material	18 mm MDF	12 mm MDF	12 mm MDF
Finish	Black Paint / White Paint	Black Paint / White Paint	Black Paint / White Paint
Grille Material & Finish	1.2 mm steel, painted	1.2 mm steel, painted	1.2 mm steel, painted
<b>Dimensions - Unpacked</b>			
Height	554 mm / 21.25"	445 mm / 17.5"	805 mm / 31.7"
Width Front	502 mm / 20"	116 mm / 4.6"	116 mm / 4.6"
Width Rear	502 mm / 20"	85 mm / 3.3"	85 mm / 3.3"
Depth	780 mm / 30.8"	115 mm / 4.5"	115 mm / 4.5"
<b>Dimensions - Packed</b>			
Height	649 mm / 25.5"	520 mm / 20.5"	880 mm / 34.5"
Width Front	588 mm / 22.75"	220 mm / 8.7"	220 mm / 8.7"
Width Rear	588 mm / 22.75"	220 mm / 8.7"	220 mm / 8.7"
Depth	865 mm / 34"	220 mm / 8.7"	220 mm / 8.7"
Net Weight	39.1 kg / 86 lbs	3 kg / / 6.6 lbs	5.6 kg / 12.32 lbs
Gross Weight	46.4 kg / 102 lbs	3.6 kg / 8 lbs	6.6 kg / 14.2 lbs

# SPECIFICATIONS: ENGINEERING NOTE

All Wharfedale Pro loudspeaker measurements are carried out fairly, and in-line with industry standards to ensure users can select the right product for their application, and understand exactly how it performs. Please see the below details on how our speakers are measured and how the information is presented.

- Sensitivity

Calculated from the effective frequency range, as the sound pressure level produced at 1 m on the reference axis by an applied voltage of 2.83v. Note: it is important to consider Rated Impedance when reviewing sensitivity measured with 2.83v input. Sensitivity ratings of 1w/m were replaced by the more appropriate 2.83v/m in AES2-2012. For more information refer to AES standard AES2-2012.

- Calculated Maximum SPL @1m

Max SPL is defined as the peak acoustic output calculated by  $10 \cdot \log(\text{Peak Power}) + \text{Sensitivity}$ . Example:  $10 \cdot \log(800) + 96 = 125\text{dB}$ .

- Power

Power, expressed in units of watts is defined by the equation  $v^2/Z$  where  $v$ =voltage input and  $Z$ =Rated Impedance. Example:  $492/8=300$  watts. Using band limited pink noise, the voltage average is measured with a true RMS meter. Band limited signal Crest Factor is typically 12dB, meaning that peaks deliver 4 x the  $v$ , or 16 x the power of the average input level.

Note: Loudspeaker power rating is a complex topic. WP endeavors to demystify power ratings by explaining procedures. The AES2-2012 standard for loudspeaker drivers in section 6 describes power handling. Be aware that the AES power handling ratings are for an accelerated two-hour test designed as a repeatable test to define a benchmark to compare loudspeaker drivers. The AES2-2012 section 6 definition is in no way intended to define long term operating power levels, nor is it appropriate for systems.

- Continuous Power

The average dynamic power capacity over the device's recommended bandwidth that may be sustained continuously. WP test with band limited pink noise applied for a minimum of eight hours.

- Program Power

Program power is a useful rating to guide the choice of amplifier power that may safely be coupled to the system. Common sense must be considered dependent on the source signal."

- Peak Power

The capacity to withstand short peaks, typically less than 10ms, delivered by dynamic peaks of audio signals, within the recommended bandwidth."

### **WHARFEDALE PRO LIMITED WARRANTY**

Wharfedale Pro products are warranted of manufacturing or material defects for a period of one year from the original date of purchase. In the event of malfunction, contact your authorized Wharfedale Pro dealer or distributor for information.

\*Be aware that warranty details may differ from country to country. Contact your dealer or distributor for information. These terms do not infringe your statutory rights.



Wharfedale Professional

IAG House 13/14 Glebe Road Huntingdon Cambridgeshire PE29 7DL UK

[www.wharfedalepro.com](http://www.wharfedalepro.com)

Wharfedale Professional reserves the right to alter or improve specifications without notice.

All rights reserved © 2021 Wharfedale Pro. Wharfedale Pro is a member of the IAG Group.