

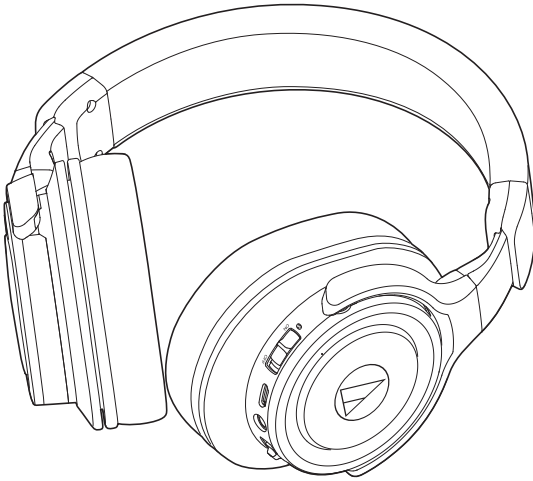

ATH-WS990BT

User Manual
Wireless Headphones



Introduction

Thank you for purchasing this Audio-Technica product.

Before using the product, please read through the Quick Start Guide and Caution Guide, as well as this user manual when necessary, to ensure that you will use the product correctly.

Safety precautions

Although this product was designed to be used safely, failing to use it correctly may result in an accident. To ensure safety, observe all warnings and cautions while using the product.

Cautions for the product

- Do not use the product near medical equipment. Radio waves may affect cardiac pacemakers and medical electronic equipment. Do not use the product inside medical facilities.
- When using the product in aircraft, follow airline instructions.
- Do not use the product near automatic control devices such as automatic doors and fire alarms. Radio waves may affect electronic equipment and cause accidents due to malfunction.
- Do not disassemble, modify or attempt to repair the product to avoid electric shock, malfunction or fire.
- Do not subject the product to strong impact to avoid electric shock, malfunction or fire.
- Do not handle the product with wet hands to avoid electric shock or injury.
- Disconnect the product from a device if the product begins to malfunction, producing smoke, odor, heat, unwanted noise or showing other signs of damage. In such a case, contact your local Audio-Technica dealer.
- Do not allow the product to get wet to avoid electric shock or malfunction.
- Do not put foreign matter such as combustible materials, metal, or liquid in the product.
- Do not cover the product with a cloth to avoid fire or injury by overheating.
- Follow applicable laws regarding mobile phone and headphone use if using headphones while driving.
- Do not use the product in places where the inability to hear ambient sound presents a serious risk (such as at railroad crossings, train stations, and construction sites).
- When charging, make sure to use the included USB charging cable.
- Do not charge with devices that have quick-charge functionality (with a voltage of 5 V or more). Doing so may cause the product to malfunction.
- To prevent damage to your hearing, do not raise the volume too high. Listening to loud sound for an extended period may cause temporary or permanent hearing loss.
- Discontinue use if skin irritation results from direct contact with the product.
- Do not catch your fingers or other body parts between the housing and the arm or inside the joints.

Safety precautions

Cautions for rechargeable battery

The product is equipped with a rechargeable battery (lithium polymer battery).

- If battery fluid gets into eyes, do not rub them. Rinse thoroughly with clean water such as tap water and consult a doctor immediately.
- If battery fluid leaks, do not touch fluid with bare hands. If fluid remains inside the product, it may cause malfunction. If battery fluid leaks, contact your local Audio-Technica dealer.
 - If fluid gets in your mouth, gargle thoroughly with clean water such as tap water and consult a doctor immediately.
 - If your skin or clothing comes in contact with fluid, immediately wash the affected skin or clothing with water. If you experience skin irritation, consult a doctor.
- To avoid leakage, generation of heat or explosion:
 - Never heat, disassemble or modify the battery, nor dispose of it in a fire.
 - Do not attempt to pierce with a nail, hit with a hammer or step on the battery.
 - Do not drop the product or subject it to strong impact.
 - Do not get the battery wet.
- Do not use, leave or store the battery in the following places:
 - Area exposed to direct sunlight or high temperatures and humidity
 - Inside of a car under the blazing sun
 - Near heat sources such as heat registers
- Charge only with the included USB cable to avoid malfunction or fire.
- The internal rechargeable battery of this product cannot be replaced by the user. The battery may have reached the end of its service life if the usage time becomes significantly shorter even after the battery has been fully charged. If this is the case, the battery needs to be repaired. Contact your local Audio-Technica dealer for repair details.
- When the product is disposed of, the built-in rechargeable battery needs to be discarded properly. Contact your local Audio-Technica dealer to learn how to properly dispose of the battery.

For customers in the USA

FCC Notice

Warning

This device complies with Part 15 of the FCC Rules.

Operation is subject to the following two conditions: (1)

This device may not cause harmful interference, and (2) this device must accept any interference received, including interference that may cause undesired operation.

Caution

You are cautioned that any changes or modifications not expressly approved in this manual could void your authority to operate this equipment.

Note: This equipment has been tested and found to comply with the limits for a Class B digital device, pursuant to part 15 of the FCC Rules. These limits are designed to provide reasonable protection against harmful interference in a residential installation. This equipment generates, uses and can radiate radio frequency energy and, if not installed and used in accordance with the instructions, may cause harmful interference to radio communications. However, there is no guarantee that interference will not occur in a particular installation. If this equipment does cause harmful interference to radio or television reception, which can be determined by turning the equipment off and on, the user is encouraged to try to correct the interference by one or more of the following measures:

- Reorient or relocate the receiving antenna.
- Increase the separation between the equipment and receiver.
- Connect the equipment to an outlet on a circuit different from that to which the receiver is connected.
- Consult the dealer or an experienced radio/TV technician for help.

RF Exposure Statement

This transmitter must not be co-located or operated in conjunction with any other antenna or transmitter used in other systems. This device complies with FCC radiation exposure limits set forth for an uncontrolled environment and meets the FCC radio frequency (RF) Exposure Guidelines. This equipment has very low levels of RF energy that is deemed to comply without testing of specific absorption rate (SAR).

For customers in Canada

IC statement

CAN ICES-3 (B)/NMB-3(B)

This device complies with INDUSTRY CANADA R.S.S. 247.

Operation is subject to the following conditions: (1) This device may not cause harmful interference, and (2) this device must accept any interference received, including interference which may cause undesired operation.

Under Industry Canada regulations, this radio transmitter may only operate using an antenna of a type and maximum (or lesser) gain approved for the transmitter by Industry Canada. To reduce potential radio interference to other users, the antenna type and its gain should be so chosen that the equivalent isotropically radiated power (e.i.r.p.) is not more than that necessary for successful communication.

This device complies with RSS-102 radiation exposure limits set forth for an uncontrolled environment.

Notes on use

- Be sure to read the connected device's user manual before use.
- Audio-Technica will not be liable in any way for any loss of data in the unlikely event that such losses should occur while using the product.
- On public transportation or in other public places, keep the volume low so as not to disturb other people.
- Minimize the volume on your device before connecting the product.
- When using the product in a dry environment, you may feel a tingling sensation in your ears. This is caused by static electricity accumulated on your body, not by product malfunction.
- Do not subject the product to strong impact.
- Do not store the product in direct sunlight, near heating devices, or in hot, humid, or dusty places. Additionally, do not allow the product to get wet.
- When the product is used for a long time, the product may become discolored due to ultraviolet light (especially direct sunlight) and wear.
- Make sure to hold the plug when connecting and disconnecting the USB charging cable. The USB charging cable may become severed or an accident may occur if you pull on the cable itself.
- When you are not using the USB charging cable, disconnect it from the product.
- If the product is placed in a bag while the USB charging cable is still connected, the USB charging cable may become caught, severed, or broken.
- When you are not using the product, store it in the included pouch.
- This product can be used to talk on the phone only when using a mobile telephone network. Support for telephony apps that use a mobile data network is not guaranteed.
- If you use the product near an electronic device or transmitter (such as a mobile phone), unwanted noise may be heard. In this case, move the product away from the electronic device or transmitter.
- If you use the product near a TV or radio antenna, noise may be seen or heard in the television or radio signal. In this case, move the product away from the TV or radio antenna.
- To protect the built-in rechargeable battery, charge it at least once every 6 months. If too much time passes between charges, the life of the rechargeable battery may be reduced, or the rechargeable battery may no longer be able to be charged.
- The volume of the product differs depending on if the noise-cancelling function is on or off.
- The hear-through mode of the product allows you to hear the sounds around you through the built-in microphone while you are wearing the product. Depending on the volume of the music being played back, the surrounding sounds may be difficult to hear. In this case, turn down the volume of the music.
- When the hear-through mode is on, the volume of music, etc., is automatically reduced so the product can assimilate the ambient noise. This reduction in volume is normal; the product is not malfunctioning.
- Depending on your surroundings, the surrounding sounds may be difficult to hear even when using the product's hear-through mode. Do not use the product in places that could be dangerous when you cannot hear the surrounding sounds, such as places with heavy traffic.
- Operate the touch sensor with one finger. Operating with a sharp-tipped object, such as a ballpoint pen or pencil, may not only result in incorrect operation, but could also damage or break the touch sensor.
- Do not tap (touch) the touch sensor with the very tip of your finger. Doing so may cause your fingernail to break.
- If the product does not operate at all or as intended when tapped, check to make sure that your other fingers, parts of your hand, or clothing are not in contact with the product when tapping. Also, the product may not operate correctly if you are wearing gloves or if your fingertips are dry.
- The product may not operate correctly if the touch sensor is dirty from sweat. Remove any dirt before operating the product.

About the active noise-cancelling function

The product is designed to use its built-in microphone to pick up noise from the surrounding environment (noise from vehicles, noise from air conditioners, etc.) and to cancel out that noise by producing sounds in negative phase. This results in a reduction in the sounds in your environment.

- The product's noise-cancelling function mainly reduces noises of 300 Hz or lower. Because of this, it has almost no effect on noises above that frequency (ringtones, speaking voices, etc.).
- Not all sounds are cancelled.
- Depending on the type of noise (or in quiet locations), you may not notice the noise-cancelling effect.
- There is a "humming" sound when you turn on the noise-cancelling function. This is the sound of the noise-cancelling function operating; it is not a malfunction.

For a more comfortable Bluetooth® communication experience

The effective communication range of this product varies depending on obstructions and radio wave conditions.

For a more enjoyable experience, please use the product as close as possible to the Bluetooth device. To minimize noise and sound disruptions, avoid placing your body or other obstacles between the product's antenna (L side) and the Bluetooth device.

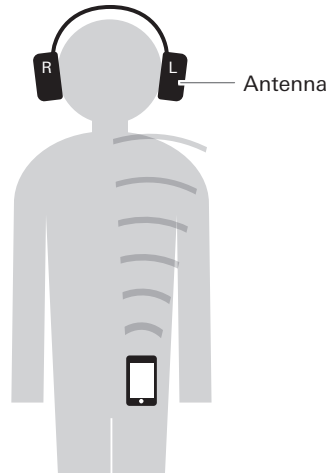

Part names and functions

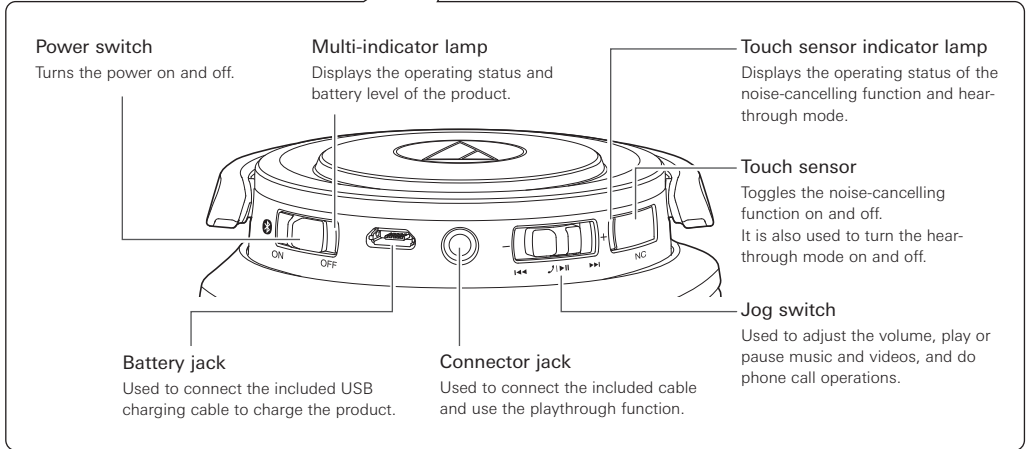
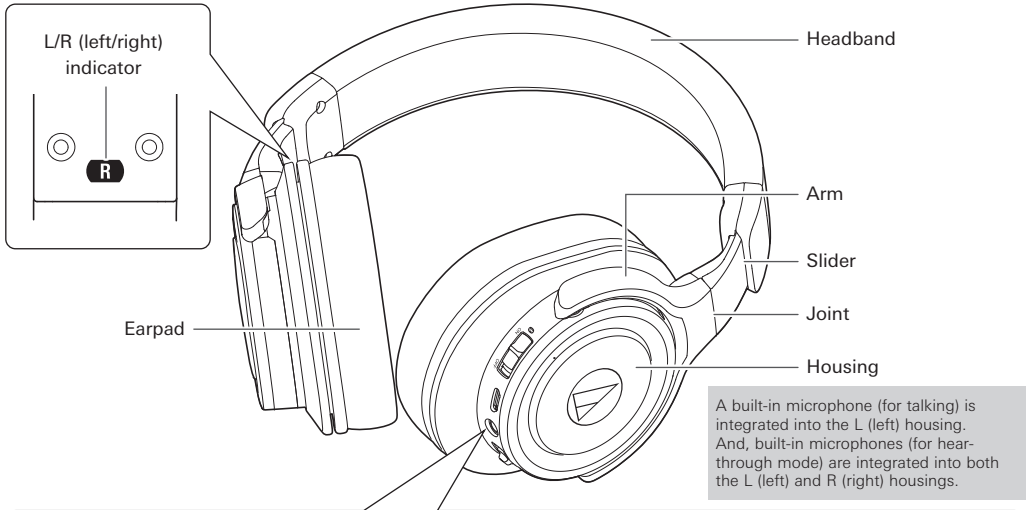

■ Accessories



- Cable (1.2 m (3.9')/3.5 mm (1/8") gold-plated stereo mini-plug, L-shaped)

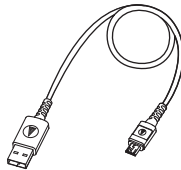

- USB charging cable (30 cm (12"))

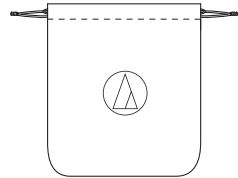

- Pouch

Charging the battery

- Fully charge the battery when using it for the first time.
- When the rechargeable battery is running low, the product will sound 2 sets of 2 beeps through the headphones, and the multi-indicator lamp will flash in red. When these beeps sound, charge the battery.
- It takes about 5 hours to charge the battery fully (this time may vary depending on usage conditions).
- While the battery is charging, the product's Bluetooth connection remains disabled and therefore the product's Bluetooth function cannot be used.

1. Connect the included USB charging cable (micro USB Type-B side) to the product's battery jack.
 - The included USB charging cable is designed for exclusive use with the product. Do not use any other USB charging cable.
 - When inserting the included USB charging cable into the USB port or battery jack, check that the jack is facing in the correct direction before inserting it directly (horizontally).

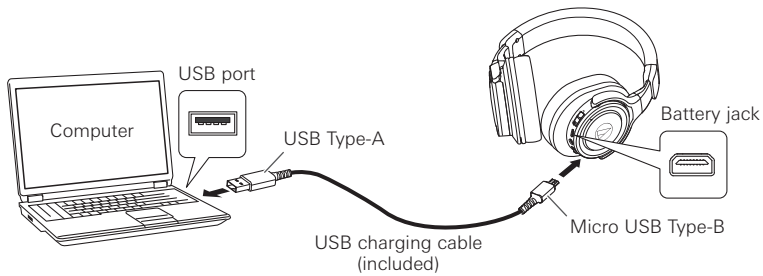

2. Connect the included USB charging cable (USB Type A-side) to the computer to start charging.
 - While charging, the multi-indicator lamp lights as follows (it may take several seconds for the multi-indicator lamp to light).
Lit in red: Charging
Unlit: Charging complete
3. When charging is complete, disconnect the included USB charging cable (USB Type-A side) from the computer.
4. Disconnect the included USB charging cable (Micro USB Type-B) from the battery jack.

- If you charge the product with its power on, it will turn off while the product is charging. After charging is complete, the product turns back on when you remove the included USB charging cable.

Connecting via Bluetooth wireless technology

About pairing

To connect the product to a Bluetooth device, the product needs to pair (register) with the device. Once they are paired, you do not need to pair them again.

However, you need to pair again in the following cases:

- If the product is deleted from the Bluetooth device's connection history
- If the product is sent out for repair
- If 9 or more devices are paired
(This product can save the pairing information of up to 8 devices. If you attempt to pair a new device when 8 devices have already been paired, the pairing information of the new device will overwrite the information of the device within the 8 paired devices that has the oldest date and time for connection to the product.)

Pairing a Bluetooth device

- Read the user manual for the Bluetooth device.
 - Place the Bluetooth device within 1 m (3.3') of the product to pair correctly.
 - To confirm the progress of the pairing process, wear the product while performing this procedure and listen for the confirmation tone.
1. Starting with the product turned off, turn the power switch on.
 - After the multi-indicator lamp lights white, it begins to flash.
 2. Use your Bluetooth device to begin the pairing process and search for the product.
When your Bluetooth device finds the product, "ATH-WS990BT" will be displayed on the device.
 - For information about using your Bluetooth device, refer to the device's user manual.
 3. Select "ATH-WS990BT" to pair the product and your Bluetooth device.
 - Some devices may ask for a passkey. In this case, enter "0000". The passkey may also be called a passcode, PIN code, PIN number, or password.
 - The product sounds a confirmation tone when pairing is complete.

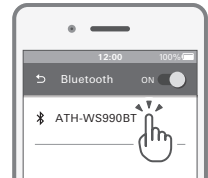

Using the product

The product can use Bluetooth wireless technology to connect to your device and play music, receive phone calls, etc. Use the product for whichever of these purposes suits your needs.

Note that Audio-Technica cannot guarantee the operation of displays, such as the battery level display, or applications via Bluetooth devices.

Power supply on/off

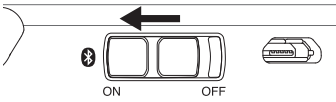
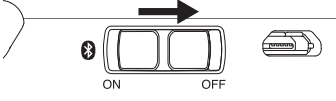
Power supply	Power switch operation	Multi-indicator lamp
ON		Lights in white, and then flashes in white ^{*1 *2}
OFF		Lights in white, then turns off ^{*2}

*1 It may take several seconds for the multi-indicator lamp to light.

*2 For details, please refer to "Multi-indicator lamp display" (p. 15).

Wearing the product

Place the side of the product marked "L" (left) on your left ear and the side marked "R" (right) on your right ear, and then adjust the headband by sliding the slider up and down until the earpads cover your ears.



Swivel mechanism

You can fold the housing so that it lies flat.

- The swivel mechanism cannot rotate more than 90 degrees. Do not apply excessive force to this mechanism.

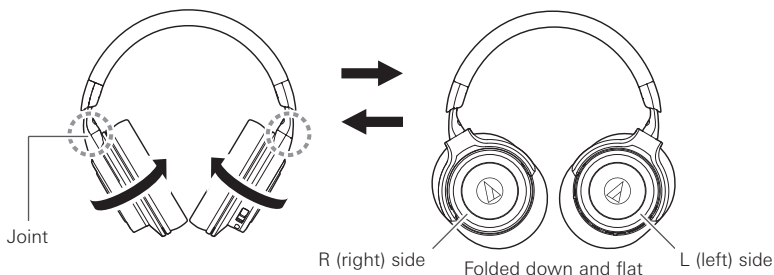

Using the product

Listening to audio

- To connect for the first time, pair the product and your device via Bluetooth wireless technology. Once they are paired, turn on the Bluetooth device's Bluetooth connection, and then turn on the product.
- Use your Bluetooth device to start playback, referring to the device's user manual as necessary.

Jog switch

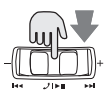
Press	Plays or pauses music and videos. ^{*1}	
Press and hold	The speech recognition function (such as Siri, which is installed on iOS devices) may start depending on the connected device.	

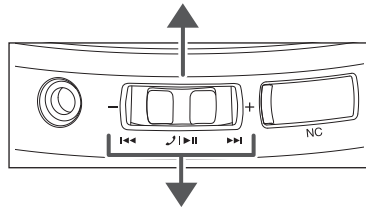

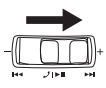
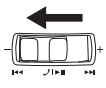
Slide toward +	Slide and release	Increases the volume by 1 level. ^{*2}	
	Slide and hold (about 2 seconds)	Plays the next track. ^{*1}	
Slide toward -	Slide and release	Decreases the volume by 1 level. ^{*2}	
	Slide and hold (about 2 seconds)	Plays the previous track. ^{*1}	

^{*1} On some smartphones, you may not be able to do some operations, such as playing/pausing music and videos or going to the next/returning to the previous track.

^{*2} A confirmation tone sounds each time you slide the jog switch. A low beep is heard when the volume is at the maximum or minimum level.

- The volume control of some devices may not work well with the product.

Using the noise-cancelling function

The built-in microphones pick up the noise around you, allowing the product to produce a canceling signal to effectively reduce the noise.

The noise-cancelling function turns on automatically when you turn on the power to the product. You can toggle the noise-cancelling function on and off by double-tapping (2 presses) the touch sensor.

- The touch sensor indicator lamp lights, as follows, when you are using the noise-cancelling function.
Lit in green: noise-cancelling function is on
Unlit: noise-cancelling function is off
- There is a difference in volume depending on whether the noise-cancelling function is on or off.

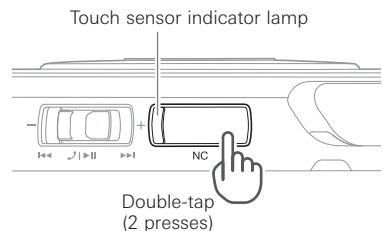

Using the product

Using the hear-through mode

The product's hear-through mode is a mode that allows you to hear the sounds around you through the built-in microphone while you are wearing the product.

- Depending on the volume of the music or audio that you are playing, it may be difficult to hear the sounds around you. If this happens, lower the volume of your music or audio.
 - Depending on your surroundings, it may be difficult to hear the sounds around you, even when you are using the product's hear-through mode. Do not use the product in places that are dangerous if you cannot hear the sounds around you, such as places where there is heavy traffic.
1. Long-tap (press and hold for about 2 seconds) the touch sensor while the noise-cancelling function is on.
 - The hear-through mode then turns on and the touch sensor indicator lamp flashes in green.
 - When the hear-through mode is on, the volume is automatically lowered to assimilate to the sounds around you.
 2. Once again, long-tap (press and hold for about 2 seconds) the touch sensor to turn the hear-through mode off.
 - The touch sensor indicator lamp flashes in green, and then stays lit.

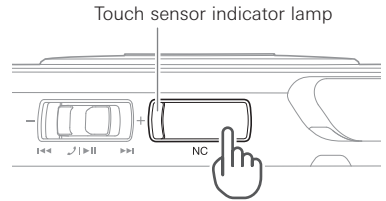

Long-tap (press and hold for about 2 seconds)

Talking on the phone

- If your Bluetooth device supports telephone features, you can use this product to talk on the phone.
- When your Bluetooth device receives a phone call, the product's ringtone sounds.
- If a call is received while you are listening to music, music playback is paused. When you finish the call, music playback resumes. *1

When	Operation	Function
Receiving a call	Press the jog switch.	Answers the call.
	Press and hold the jog switch (for about 2 seconds).	Rejects the call.
Talking on the phone	Press the jog switch.	Ends the call.
	Press and hold the jog switch (for about 2 seconds).	Each time you press and hold the jog switch (about 2 seconds), you switch the call to your mobile phone or to the product. *2
	Slide the jog switch toward + or -.	Adjusts the volume (+ or -) of the call.

*1 Depending on your Bluetooth device, music playback may not resume.

*2 When you hear the confirmation tone, release your finger from the jog switch.

- The phone call operations above may not be available on some smartphones.
- When talking on the phone, turn off the hear-through mode.

Using the product

Wired connection (playthrough function)

The product is equipped with a playthrough function so you can use it as portable headphones to play music even if the battery runs out. Connect the connector plug of the included cable to the product's connector jack, and then connect the input plug to your portable player so you can use it. If the product has some remaining battery power, you can use the noise-cancelling function and the hear-through mode even while you are using the playthrough function.

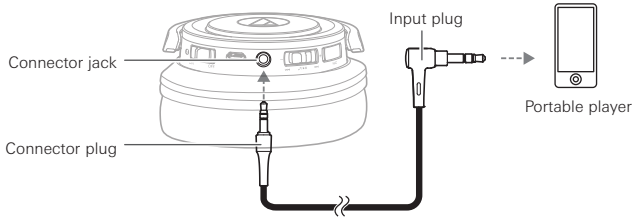

Auto power off function

The Bluetooth connection automatically turns off after 5 minutes if the product is not connected to a device that is turned on.

- The noise-cancelling function (including the hear-through mode) remains on. Be careful that the battery does not run out.

Reset function

If the product does not work, or if any other malfunctions occur, refer to "Charging the battery" (p. 6) for information on inserting the USB charging cable to provide power, and then do a reset.

Disconnecting and then reconnecting the included USB charging cable will reset the product and should resolve any problem you are experiencing. If the problem persists, please contact your local Audio-Technica dealer.

Resetting the product does not initialize any settings, such as those for pairing and volume. *

* The SBC priority connection (p. 14) is disconnected.

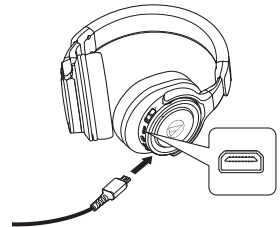

Cleaning

Get into the habit of regularly cleaning the product to ensure that it lasts for a long time. Do not use alcohol, paint thinners or other solvents for cleaning purposes.

- To clean the product, wipe it with a dry cloth.
 - Wipe away perspiration or any other dirt from the cable with a dry cloth immediately after use. Failure to clean the cable may cause it to deteriorate and harden over time, resulting in malfunctions.
 - Wipe the plug with a dry cloth if it is dirty. Failure to clean the plug may cause the audio to cut out and may cause noise.
 - Wipe the earpads and headband with a dry cloth if they are dirty. Perspiration or water on the earpads or headband may cause discoloration. Wipe them with a dry cloth and allow them to dry in the shade.
-
- If the product will not be used for an extended period of time, store it in a well-ventilated place, free from high temperatures and humidity.
 - Earpads are consumable items. They deteriorate over time due to use and storage, so replace them when necessary. For information about replacing earpads or other parts, or for information about other serviceable parts, contact your local Audio-Technica dealer.

Troubleshooting

Problem	Solution
Power is not supplied	<ul style="list-style-type: none">• Charge the product.
Unable to pair	<ul style="list-style-type: none">• Confirm that the Bluetooth device communicates using Ver. 2.1+EDR or higher.• Place the product and the Bluetooth device within 1 m (3.3') of each other.• Set the profiles for the Bluetooth device. For procedures on how to set profiles, refer to the Bluetooth device's user manual.• Remove the pairing information for the product and the Bluetooth device, and then pair the product with the device again.
No sound is heard or the sound is faint	<ul style="list-style-type: none">• Turn on the power of the product and the Bluetooth device.• Turn up the volume of the product and the Bluetooth device.• If the Bluetooth device is set to the HFP/HSP connection, switch to the A2DP connection.• Place the product and the Bluetooth device close together and keep such obstacles as people, metal, and walls from coming between the two.• Switch the output of the Bluetooth device to the Bluetooth connection.
Sound is distorted/Noise is heard/Sound cuts out	<ul style="list-style-type: none">• Turn down the volume of the product and the Bluetooth device.• Keep the product away from devices that emit radio waves, such as microwave and wireless routers.• Keep TVs, radios, and devices with built-in tuners away from the product. These devices can also be affected by the product.• Turn off the equalizer settings of the Bluetooth device.• Remove obstacles between the product and the Bluetooth device and place them closer together.• Using the settings of your Bluetooth device, turn off the aptX codec, and then connect the product.
Cannot hear the voice of the caller/Voice of the caller is too quiet	<ul style="list-style-type: none">• Turn on the power of the product and the Bluetooth device.• Turn up the volume of the product and the Bluetooth device.• If the Bluetooth device is set to the A2DP connection, switch to the HFP/HSP connection.• Switch the output of the Bluetooth device to the Bluetooth connection.• If the hear-through mode is on, turn it off.
The product cannot be charged	<ul style="list-style-type: none">• Securely connect the included USB charging cable and charge the product.
Audio is delayed (video and audio are out of sync)	<ul style="list-style-type: none">• Refer to the "SBC priority connections (for when sound is delayed significantly)" (p. 14) to change the connection codec to SBC.
Noise-cancelling effects cannot be felt	<ul style="list-style-type: none">• Confirm that the touch sensor indicator lamp is lit in green.• Put on the product again. The product may not be positioned correctly on your ears.• The noise around you may not match the canceling frequencies.

• For details about how to operate your Bluetooth device, refer to the device's user manual.

• If the problem still remains, reset the product. To reset the product, refer to "Reset function" (p. 11).

Troubleshooting

SBC priority connections (for when sound is delayed significantly)

When the connection codec is AAC, significant sound delays can be alleviated by changing the connection codec to SBC, which comes standard with Bluetooth devices. ^{*1}

Connecting to an SBC priority connection

When the pairing with a Bluetooth device has been completed

1. Turn on the product.
2. While music and videos are paused, slide the jog switch to the minus (-) side (for about 5 seconds).
 - Once the multi-indicator lamp has flashed in white 2 times, the multi-indicator lamp will begin to flash as follows: a quick, white light followed by a 3-second interval, indicating the settings are complete.
 - After the settings are complete, the Bluetooth device that was paired will be automatically connected. ^{*2}

Before pairing with a Bluetooth device

1. Turn on the product.
2. While multi-indicator lamp is searching for devices, slide the jog switch to the minus (-) side (for about 5 seconds).
 - The multi-indicator lamp will flash in white 2 times.
3. While the multi-indicator lamp continues to flash in this manner (two white flashes followed by a 0.5-second interval), refer to steps 2 and 3 in "Pairing a Bluetooth device" (p. 7) to perform the procedures for pairing.
 - The multi-indicator lamp will flash (a single, quick white flash followed by a 3-second interval) when the settings are complete.
 - After pairing via an SBC priority connection is complete, the only available connection codec will be SBC. Connections using other codecs will not be possible.
 - For details about the multi-indicator lamp's flashing and lit displays, refer to "Multi-indicator lamp display" (p. 15). ^{*3}

*1 Depending on the usage environment, changing to an SBC priority connection may not alleviate sound delays.

*2 If the product does not connect automatically, refer to "Pairing a Bluetooth device" (p. 7), and do the procedures for pairing again.

*3 Turning the power off and then back on will result in a return to a normal connection and will enable connections using other codecs. Perform the operations for an SBC priority connection each time it is necessary.

Multi-indicator lamp display

The indicator lamp of the product indicates the product's status as explained below.

Status		Multi-indicator lamp display pattern	● Red ○ White
Pairing	Searching for device	○-○-○-○-○-○-○-○-○- ...	Flashing in intervals of 0.5 seconds
	Searching for device (when using an SBC priority connection)	○○-○○-○○-○○-○○-○○-○ ...	Flashing 2 times in intervals of 0.5 seconds
Connection	Waiting to be connected	○○○○○○○○○○○○○○○○○○○...	Flashing quickly
	Connecting	○-----○-----○-----○----- ...	Flashing in intervals of 3 seconds (○ lights slowly)
	Connecting (when using an SBC priority connection)	⦿-----⦿-----⦿-----⦿----- ...	Flashing in intervals of 3 seconds (⦿ lights rapidly)
Battery level	Battery level low	The white indicator lamp for the pairing and connecting statuses changes to a red indicator lamp.	
Charging	Charging	 ...	Lit
	Fully charged	----- ...	Off

Specifications

Headphones

Type	Closed-back dynamic
Driver	53 mm
Sensitivity	101 dB/mW 107 dB/mW (when using noise-cancelling) ^{*1} 101 dB/mW (when not using noise-cancelling) ^{*1}
Frequency response	5 to 40,000 Hz
Impedance	30 ohms 150 ohms (when using noise-cancelling) ^{*1} 30 ohms (when not using noise-cancelling) ^{*1}

Microphone

Type	Electret condenser
Polar pattern	Omnidirectional
Sensitivity	-44 dB (1 V/Pa, at 1 kHz)
Frequency response	50 to 4,000 Hz

Communication specifications

Communication system	Bluetooth version 4.1
RF output	3.2 mW EIRP
Maximum communication range	Line of sight - approx. 10 m (33')
Frequency band	2.402 GHz to 2.480 GHz
Modulation method	FHSS
Compatible Bluetooth profiles	A2DP, AVRCP, HFP, HSP
Support codec	Qualcomm® aptX™ audio, AAC, SBC
Supported content protection method	SCMS-T
Transmission band	20 to 20,000 Hz

Specifications

Other

Power supply	DC 3.7 V lithium polymer battery
Charging time	Approx. 5 hours ^{*2}
Operating time	Continuous transmission time (music playback): Max. approx. 25 hours (when using Bluetooth and noise-cancelling) ^{*2} Max. approx. 30 hours (when using only Bluetooth) ^{*2} Max. approx. 35 hours (when using only noise-cancelling) ^{*2} Continuous standby time: Max. approx. 1,000 hours ^{*2}
Weight	Approx. 300 g (10.6 oz)
Operating temperature	5 °C to 40 °C (41 °F to 104 °F)
Accessories	<ul style="list-style-type: none">• USB charging cable (30 cm (12"), USB Type-A/Micro USB Type-B)• Cable (1.2 m (3.9'))• Pouch
Sold separately	<ul style="list-style-type: none">• Earpad• Cable

*1 When using a wired connection

*2 The above figures depend on operating conditions.

For product improvement, the product is subject to modification without notice.

- The Bluetooth® word mark and logos are owned by Bluetooth SIG, Inc., and any use of such marks by the Audio-Technica Corporation is under license. All other trademarks are property of their respective owners.
- The "AAC" logo is a trademark of Dolby Laboratories.
- Qualcomm is a trademark of Qualcomm Incorporated, registered in the United States and other countries, used with permission. aptX is a trademark of Qualcomm Technologies International, Ltd., registered in the United States and other countries, used with permission.

Audio-Technica Corporation

2-46-1 Nishi-naruse, Machida, Tokyo 194-8666, Japan
www.audio-technica.co.jp

©2018 Audio-Technica Corporation

138901010-02-01 ver.1 2018.02.15