



GLXD4

Wireless Receivers

The Shure GLXD4 Wireless Receiver online user guide.
Version: 6.1 (2021-E)

Table of Contents

GLXD4 Wireless Receivers	3	Setting Up Receivers and Transmitters	16
IMPORTANT SAFETY INSTRUCTIONS	3	Manually Linking a Transmitter to a Receiver	16
WARNING	4	Combo Systems	17
Note:	4	2.4 GHz Spectrum Overview	17
Australia Warning for Wireless	4	Overcoming the Challenges of 2.4GHz	17
System Overview	4	Coexisting with Wi-Fi	17
Accessories	5	Challenging Wireless Environments	17
Furnished Accessories	5	Tips and Methods to Improve Wireless System Performance	18
Optional Accessories	5	2.4 GHz Frequency Tables	18
Quick Start	5	Firmware	19
GLXD4 Receiver Controls and Connectors	7	Connect to the Computer	20
Receiver Screen	9	Operation	20
Transmitters	10	Gain Adjustment	20
Transmitter Status LED	11	Locking and Unlocking the Controls	21
Wearing the Bodypack Transmitter	11	Identifying Linked Transmitters and Receivers with Remote ID	21
Wearing the Headworn Microphone	12	Manually Selecting a Group and Channel	21
Correct Microphone Placement	12	Troubleshooting	22
Batteries and Charging	12	Resetting Components	24
Receiver Charging Bay	13	Resetting the Receiver	24
Charging from an AC Power Source	13	Resetting the Transmitter	24
Charging from a USB Port	13	Specifications	24
LED Status During Charging	14	Pin Assignments	26
Installing Transmitter Batteries	14	Dimensions	27
Charging Times and Transmitter Runtimes	15	Certifications	30
Important Tips for Care and Storage of Shure Rechargeable Batteries	15	Information to the user	31
Multiple Receiver Systems	15		

GLXD4

Wireless Receivers

IMPORTANT SAFETY INSTRUCTIONS







1. READ these instructions.
2. KEEP these instructions.
3. HEED all warnings.
4. FOLLOW all instructions.
5. DO NOT use this apparatus near water.
6. CLEAN ONLY with dry cloth.
7. DO NOT block any ventilation openings. Allow sufficient distances for adequate ventilation and install in accordance with the manufacturer's instructions.
8. DO NOT install near any heat sources such as open flames, radiators, heat registers, stoves, or other apparatus (including amplifiers) that produce heat. Do not place any open flame sources on the product.
9. DO NOT defeat the safety purpose of the polarized or grounding type plug. A polarized plug has two blades with one wider than the other. A grounding type plug has two blades and a third grounding prong. The wider blade or the third prong are provided for your safety. If the provided plug does not fit into your outlet, consult an electrician for replacement of the obsolete outlet.
10. PROTECT the power cord from being walked on or pinched, particularly at plugs, convenience receptacles, and the point where they exit from the apparatus.
11. ONLY USE attachments/accessories specified by the manufacturer.
12. USE only with a cart, stand, tripod, bracket, or table specified by the manufacturer, or sold with the apparatus. When a cart is used, use caution when moving the cart/apparatus combination to avoid injury from tip-over.



13. UNPLUG this apparatus during lightning storms or when unused for long periods of time.
14. REFER all servicing to qualified service personnel. Servicing is required when the apparatus has been damaged in any way, such as power supply cord or plug is damaged, liquid has been spilled or objects have fallen into the apparatus, the apparatus has been exposed to rain or moisture, does not operate normally, or has been dropped.
15. DO NOT expose the apparatus to dripping and splashing. DO NOT put objects filled with liquids, such as vases, on the apparatus.
16. The MAINS plug or an appliance coupler shall remain readily operable.
17. The airborne noise of the Apparatus does not exceed 70dB (A).
18. Apparatus with CLASS I construction shall be connected to a MAINS socket outlet with a protective earthing connection.
19. To reduce the risk of fire or electric shock, do not expose this apparatus to rain or moisture.
20. Do not attempt to modify this product. Doing so could result in personal injury and/or product failure.
21. Operate this product within its specified operating temperature range.

Explanation of Symbols

	Caution: risk of electric shock
---	---------------------------------

	Caution: risk of danger (See note.)
	Direct current
	Alternating current
	On (Supply)
	Equipment protected throughout by DOUBLE INSULATION or REINFORCED INSULATION
	Stand-by
	Equipment should not be disposed of in the normal waste stream

WARNING: Danger of explosion if incorrect battery replaced. Operate only with AA batteries.

WARNING: Battery packs shall not be exposed to excessive heat such as sunshine, fire, or the like.



- Battery packs may explode or release toxic materials. Risk of fire or burns. Do not open, crush, modify, disassemble, heat above 140°F (60°C), or incinerate
- Follow instructions from manufacturer
- Never put batteries in mouth. If swallowed, contact your physician or local poison control center
- Do not short circuit; may cause burns or catch fire
- Do not charge or use battery packs with other than specified Shure products
- Dispose of battery packs properly. Check with local vendor for proper disposal of used battery packs

Note:

- This equipment is intended to be used in professional audio applications.
- EMC conformance is based on the use of supplied and recommended cable types. The use of other cable types may degrade EMC performance.
- Use this battery charger only with the Shure charging modules and battery packs for which it is designed. Use with other than the specified modules and battery packs may increase the risk of fire or explosion.
- Changes or modifications not expressly approved by Shure Incorporated could void your authority to operate this equipment.

Note: Use only with the included power supply or a Shure-approved equivalent.

Australia Warning for Wireless

This device operates under an ACMA class licence and must comply with all the conditions of that licence including operating frequencies. Before 31 December 2014, this device will comply if it is operated in the 520-820 MHz frequency band.

WARNING: After 31 December 2014, in order to comply, this device must not be operated in the 694-820 MHz band.

System Overview

The new groundbreaking GLX-D Wireless Systems from Shure combine the leading edge of Automatic Frequency Management technology with best-in-class intelligent lithium-ion battery rechargeability, world-renowned microphones and unparalleled design and construction. Available in a wide offering of bodypack and handheld configurations - including vocal, headset and presenter systems as well as traditional guitar options. The revolutionary GLX-D Wireless Systems define the newest standard for seamless ease of operation and exceptional digital audio clarity.

- Exceptional digital audio clarity
- Operates in 2.4 GHz spectrum, available worldwide
- Rechargeable batteries deliver cost-efficiency and up to 11.5 hours of runtime
- Adjustable transmitter gain to optimize audio signal
- Automatically moves away from interference without audio interruption
- RF back-channel for remote control of transmitter functions
- Globally-unlicensed 2.4 GHz frequency band allows operation of up to 4 compatible systems in a typical setting and up to 8 compatible systems under ideal conditions
- Automatic transmitter power-off to conserve battery life when transmitter is not in use

Accessories

Furnished Accessories

Power Supply	PS43
Carrying Case	95E16526
Shure Lithium-Ion Rechargeable Battery	SB902A
USB Cable, Type A to Micro-B	95A21651

* Only included with GLXD14 or GLXD24 systems.

Optional Accessories

Black Bodypack Pouch	WA582B
-----------------------------	--------

Quick Start

To reduce set up time, the transmitter and receiver automatically link to form an audio channel the first time they are powered on and never have to be linked again.

Note: When setting up multiple receiver systems, turn on and link each transmitter/receiver pair one at a time to prevent cross-linking.

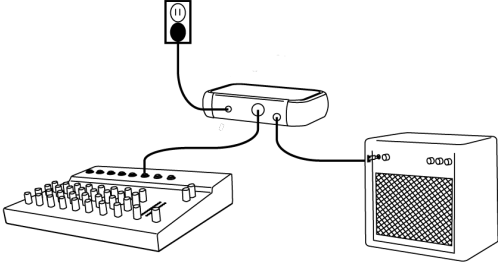
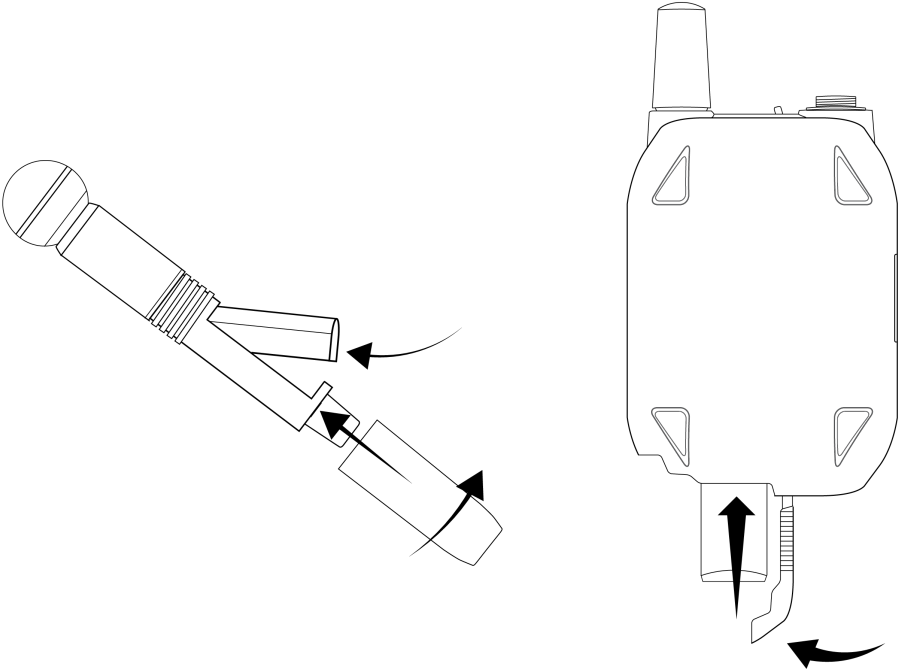
<p>Step ①</p>	<p>Connect power supply to the receiver and plug cord into an AC power source. Connect the</p>  <p>audio output to an amplifier or mixer.</p>
<p>Step ②</p>	<p>Install charged transmitter batteries.</p> 

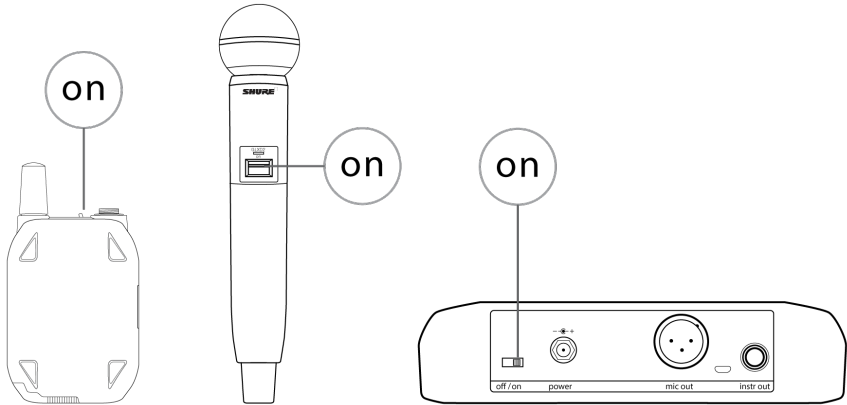
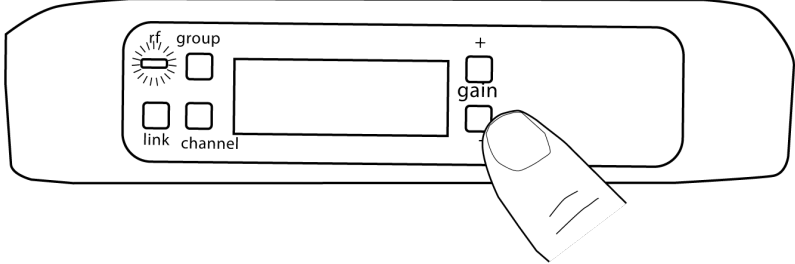
<p>Step ③</p>	<p>Turn on the transmitter and receiver. The blue RF LED will flash while the transmitter and receiver form a link. When the link has successfully formed, the RF LED will remain illuminated.</p>  <p>ed.</p> <p>Note: The transmitter and receiver will remain linked for future usage. At power-up, the blue RF LED will illuminate, skipping the linking step.</p>
<p>Step ④</p>	<p>Check the audio and adjust the gain if necessary.</p> 

GLXD4 Receiver Controls and Connectors

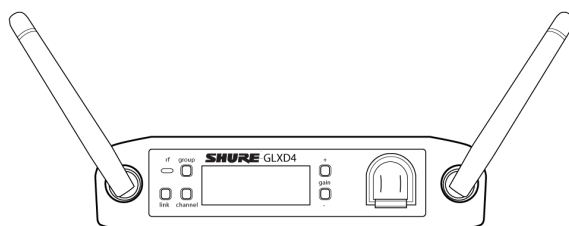

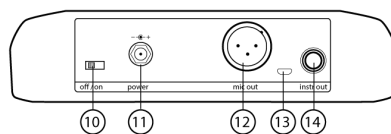

① Antenna

Two antennas per receiver. Antennas pick up the signal from the transmitter.

② RF Status LED

- ON = Linked transmitter is on
- Flashing = Searching for transmitter
- OFF = Linked transmitter off or transmitter unlinked

③ Group Button

Press and hold for two seconds to enable manual group edit.

④ Link Button

Press to manually link receiver to a transmitter or to activate the remote ID function

⑤ Channel

- Momentary press to start a channel scan
- Press and hold 2 seconds to enable manual channel edit

⑥ LCD Screen

Displays receiver and transmitter status.

⑦ Gain Buttons

Press to increase or decrease transmitter gain in 1 dB increments.

⑧ Battery Charging Indicator

Illuminates when battery is in charging bay:

- Red = battery charging
- Green Flashing = battery charge > 90%
- Green = battery charged
- Amber Flashing = charging error, replace battery

⑨ Battery Charging Bay

Charges transmitter battery.

⑩ Power Switch

Powers the unit on and off.

Note: The battery continues to charge even when the switch is off.

⑪ Power Supply Jack

Connect the supplied 15 V DC external power supply.

⑫ Mic Out

XLR microphone output jack supplies microphone-level audio output.

⑬ USB Port

For uploading firmware updates

⑭ Instr Out

TRS ¼" (6.35mm) audio output. Connect to mixers, recorders, and amplifiers.

Receiver Screen

① Group

Displays the selected group.

② Channel

Displays the selected channel.

③ Transmitter Battery Runtime

Displays remaining battery life in hours and minutes.

Alternatively displays the following battery status:

- CALC = battery life calculation
- Lo = battery life less than 15 minutes
- Err = replace battery

④ Audio Meter

Indicates audio signal level and peaks.

⑤ Gain

Displays transmitter gain settings (dB).

⑥ OL Indicator

Indicates audio overload, reduce gain.

⑦ Transmitter Locked

Displayed when linked transmitter controls are locked.

⑧ Scanning

Indicates a scan is in progress.

⑨ Auto

Indicates that the selected group has backup channels available.

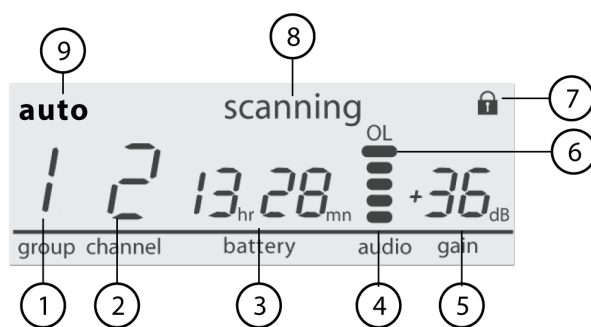

Transmitters

① Antenna

Carries wireless signal.

② Status LED

LED color and state indicate transmitter status.

③ Power Switch

Turns the transmitter on/off.

④ TA4M Input Jack

Connects to a 4-Pin mini connector (TA4F) microphone or instrument cable.

⑤ Micro USB Charging Port

Connect to USB battery charger.

⑥ Link Button

- Press and hold within 5 seconds of power-on to manually link with receiver
- Press momentarily to activate Remote ID function

⑦ Battery Compartment

Holds 1 Shure rechargeable battery.

⑧ Microphone Cartridge

GLXD-2 transmitter models are available with the following cartridge types: SM58, Beta 58, SM86, Beta 87A.

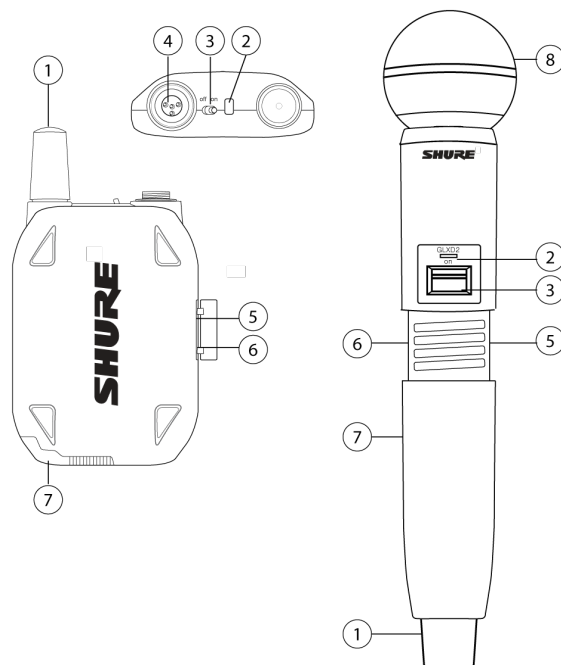

Transmitter Status LED

LED is green during normal operation.

LED color or flashing indicates a change in transmitter status as shown in the following table:

Color	State	Status
Green	Flashing (slow)	transmitter attempting relink with receiver
	Flashing (fast)	unlinked transmitter searching for receiver
	Flashes 3 times	indicates locked transmitter when power switch is pressed
Red	On	battery life < 1 hour
	Flashing	battery life < 30 minutes
Red/Green	Flashing	remote ID active
Amber	Flashing	battery error, replace battery

Wearing the Bodypack Transmitter

Clip the transmitter to a belt or slide a guitar strap through the transmitter clip as shown.

For best results, the belt should be pressed against the base of the clip.

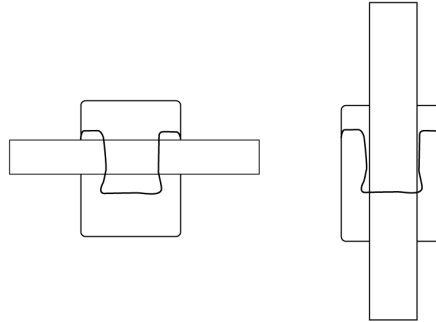

Wearing the Headworn Microphone

- Position the headworn microphone 13 mm (1/2 in.) from the corner of your mouth.
- Position lavalier and headworn microphones so that clothing, jewelry, or other items do not bump or rub against the microphone.

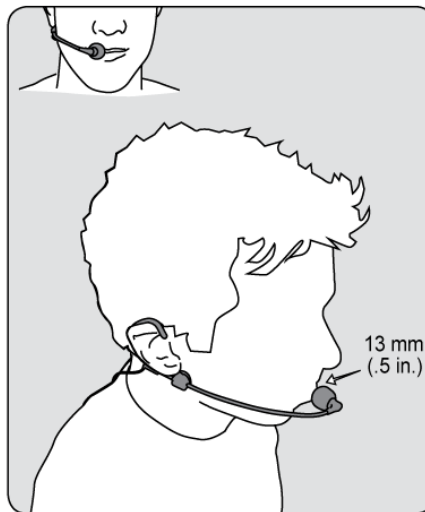

Correct Microphone Placement

- Hold the microphone within 12 inches from the sound source.
- For a warmer sound with increased bass presence, move the microphone closer to the sound source.
- Do not cover grille with hand.

Batteries and Charging

GLX-D transmitters are powered by Shure SB902A lithium-ion rechargeable batteries. Advanced battery chemistry maximizes runtimes with zero memory effects, eliminating the need to discharge batteries prior to charging.

When not in use, recommended battery storage temperature is 10°C (50°F) to 25°C (77°F).

Note: The transmitter will not pass RF or audio signals when connected to the charging cable.

The following battery charging options are available:

Receiver Charging Bay

The GLXD4 receiver has a built-in charging bay for the transmitter batteries.

1. Insert the battery into the charging bay.
2. Monitor the battery charging indicator on the front panel until charging is complete.

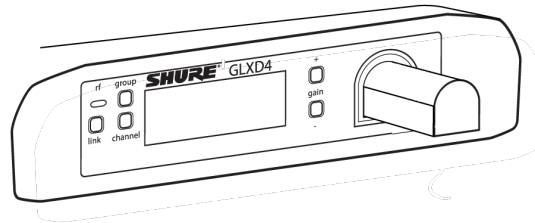

Charging from an AC Power Source

1. Plug the charging cable into the charging port on the transmitter.
2. Plug the charging cable into an AC power source.

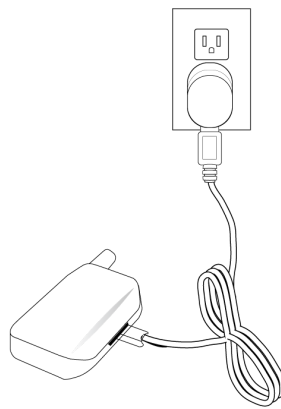

Charging from a USB Port

1. Plug the USB charging cable into the charging port on the transmitter.
2. Plug the cable into a standard USB port.

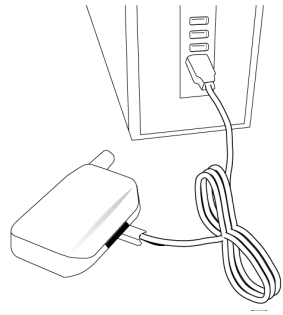

LED Status During Charging

The following LED states indicate battery status when the transmitter is connected to a charger:

- Green = charging complete
- Green Flashing = battery charge > 90%
- Red = battery charging
- Amber Flashing = battery error, replace battery

Installing Transmitter Batteries

Bodypack Transmitter

1. Move the locking lever to the open position and slide the battery door open.
2. Place the battery into the transmitter.
3. Close the battery door and slide the latch to lock.

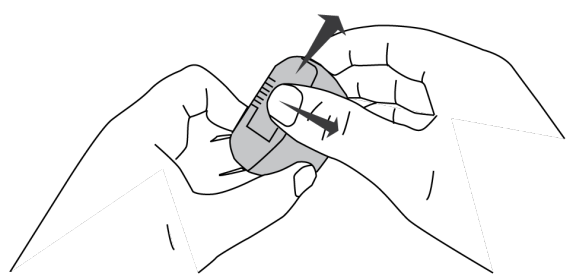

Handheld Transmitter

1. Unscrew and remove the battery cover.
2. Place the battery into the transmitter.
3. Replace and tighten the battery cover.

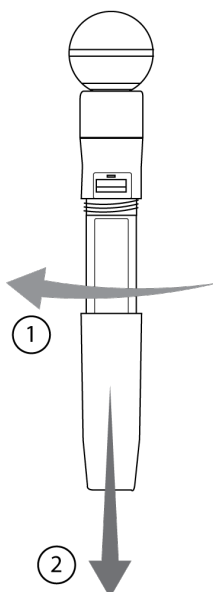

Charging Times and Transmitter Runtimes

Use the following table to determine approximate battery runtime based on the duration of charging time. Times shown are in hours and minutes. GLX-D transmitters automatically power-off after approximately 1 hour to conserve battery life if the signal from a linked receiver is not detected.

Receiver Bay or AC Power Source Charging	USB Connection Charging	Transmitter Runtime
0:15	0:30	up to 1:30
0:30	1:00	up to 3:00
1:00	2:00	up to 6:00
3:00	4:00	up to 11:30*

*Storage time or excessive heat will reduce maximum runtime.

Note: If receiver is powered off and remains plugged in, battery will continue charging.

Important Tips for Care and Storage of Shure Rechargeable Batteries

Proper care and storage of Shure batteries results in reliable performance and ensures a long lifetime.

- Always store batteries and transmitters at room temperature
- Ideally, batteries should be charged to approximately 40% of capacity for long-term storage
- During storage, check batteries every 6 months and recharge to 40% of capacity as needed

Important: Always fully charge a new battery before first use, in receiver if possible.

Multiple Receiver Systems

For ease of set up, frequencies are divided into groups to best match the channel requirements for your system.

Select the group by determining the total number of receivers in your system (channel count). All receivers in the system must be set to the same group.

Group	Channel Count (Number of Receivers)	Number of Backup Frequencies	Notes
1	Up to 4	3	Initial factory setting.
2	Up to 5*	3	Best multi-channel group if you experience interference.
3	Up to 8*	0	For large multi-channel systems. Only use Group 3 in controlled Wi-Fi environments because there are no backup frequencies to avoid interference.
4	1	27	Best single-channel group if you experience interference.

*Environmentally dependent, 4 systems typical

See "Tips to Improve Wireless System Performance" section for additional information.

Setting Up Receivers and Transmitters

Note: Before beginning, turn off all receivers and transmitters. Turn on and set up each receiver/transmitter pair individually to prevent cross-linking.

1. Turn on the first receiver.
2. Press and hold the group button to select a group (if necessary) or if the group is already set, press the channel button to scan for the best available channel.
3. Turn on the first transmitter. The blue rf LED will illuminate when a link is established.

Repeat steps 1-3 for each additional receiver and transmitter. Remember to set each receiver to the same group.

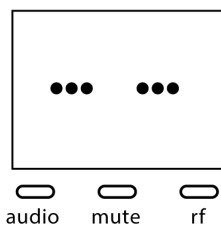

Note: Dashes appearing on the group and channel display during a channel scan indicate that frequencies are not available in the selected group. Choose a group that supports more receivers and repeat the set up steps.

Manually Linking a Transmitter to a Receiver

Use the manual linking option to change the transmitter linked to a receiver. A common use for manual linking is changing the linked transmitter from a bodypack type to a handheld type.

1. Turn on the transmitter: Within 5 seconds, press and hold the LINK button until the transmitter LED begins to flash green.

2. Press and hold the link button on the receiver: The blue rf LED will flash, and then remain on when the link has been established.
3. Test the audio to verify the link and adjust the gain if necessary.

Combo Systems

A combo system is created by linking two transmitters to a single receiver. Only one transmitter can be active at a time to prevent cross interference. Gain settings for each transmitter can be independently set and stored when the transmitter is active.

Important! Do not turn on and operate both linked transmitters at any time.

Turn off both transmitters before beginning.

1. Press the group button to select a group. The receiver automatically scans the selected group to find the best available channel.
2. Turn on transmitter 1 and link it to the receiver. Adjust the gain, and then turn off the transmitter.
3. Turn on transmitter 2 and link it to the receiver. Adjust the gain, and then turn off the transmitter.

2.4 GHz Spectrum Overview

GLX-D operates within the 2.4GHz ISM band which is utilized by Wi-Fi, Bluetooth, and other wireless devices. The benefit of 2.4GHz is that it's a global band that can be used anywhere in the world, license free.

Overcoming the Challenges of 2.4GHz

The challenge of 2.4GHz is that Wi-Fi traffic can be unpredictable. GLX-D meets these challenges in the following ways:

- Prioritizes and transmits on the best 3 frequencies per channel (choosing from a pool of 6 frequencies across the 2.4GHz band)
- Repeats the most important information such that one frequency can be taken out entirely without audio interruption
- Continuously scans during usage to rank all frequencies (both current and backup frequencies)
- Seamlessly moves away from interference to backup frequencies without audio interruption

Coexisting with Wi-Fi

If you plan to use Wi-Fi during a performance, turn on Wi-Fi devices prior to turning on GLX-D and scanning for the best channel. GLX-D detects and avoids other Wi-Fi traffic by scanning the entire 2.4GHz environment and selecting the 3 best frequencies to transmit on. The result of this is reliable performance for your GLX-D wireless system as well as avoiding Wi-Fi transmissions which may be important as well.

"Bursting" Wi-Fi is harder to detect as it is periodic; however, because GLX-D repeats the most important information, even bursts at very high-levels don't have an effect on your audio performance.

Challenging Wireless Environments

Some environments are more difficult than others for 2.4 GHz wireless system performance. Additionally, body absorption has a greater impact in the 2.4 GHz spectrum, compared to the UHF spectrum. The simplest solution in many cases is to reduce the transmitter to receiver distance such as placing the receivers on the stage with a clear line of sight.

Challenging environments include:

- Areas with few reflective surfaces such as:
 - Outdoors
 - Buildings with very high ceilings
- 3 or more GLX-D receivers in use
- Strong Wi-Fi presence
- Competitive 2.4 GHz systems in use

Note: Unlike analog TV band wireless which typically uses the same type of transmissions across manufacturers, all 2.4GHz wireless currently on the market use different variations of wireless transmission. These differences make it more difficult to mix and match 2.4 GHz from multiple manufacturers successfully, as can be done with TV band wireless solutions.

Tips and Methods to Improve Wireless System Performance

If you encounter interference or dropouts, try the following suggestions:

- Scan for the best available channel (press the channel button).
- Reduce transmitter to receiver distance - for example, place receivers on stage with a line of sight to the front of the receiver.
- Change the group for all GLX-D systems:
 - Single-Channel System: use Group 4, which is optimized for single-channel use
 - Multi-Channel System: use Group 2, which is the most robust wireless group
- Move receiver further away from Wi-Fi access points, computers, or other active 2.4 GHz sources. Recommended distance is a minimum of 3 meters (10 feet).
- Disable non-critical Wi-Fi on computers, cell phones, and other portable devices
 - If you plan to use Wi-Fi during a performance, turn on Wi-Fi prior to turning on GLX-D and scanning for the best channel.
- Keep the transmitter and receiver more than 2 meters (6 feet) apart
- Avoid heavy Wi-Fi traffic activities such as downloading large files or viewing a movie.
- Locate competitive 2.4 GHz receivers away from each other
- Avoid placing transmitter and receiver where metal or other dense materials may be present
- Move the receiver to the top of the equipment rack
- Keep transmitters more than 2 meters (6 feet) apart - this is less critical at shorter receiver to transmitter distances

Note: If transmitters are within 6 inches of non-GLXD transmitters or microphone cartridges, audible noise is possible.

- During sound check, mark trouble spots and ask presenters or performers to avoid those areas
- If there is a known strong source of Wi-Fi and you specifically want to use frequencies within that Wi-Fi channel, use the following Group/Channel of GLX-D (best option listed first):
 - **Wi-Fi 1:** Group 3/Channel 8, Group 3/Channel 4
 - **Wi-Fi 6:** Group 3/Channel 7, Group 3/Channel 5
 - **Wi-Fi 11:** Group 3/Channel 2, Group 3/Channel 1

2.4 GHz Frequency Tables

The following tables list receiver channels, frequencies, and latency for each group:

Group 1: Channels 1-4 (latency = 4.0 ms)

Group/Channel	Frequencies
1/1	2424 2425 2442 2443 2462 2464
1/2	2418 2419 2448 2450 2469 2471
1/3	2411 2413 2430 2431 2476 2477
1/4	2405 2406 2436 2437 2455 2457

Group 2: Channels 1-5 (latency = 7.3 ms)

Group/Channel	Frequencies
2/1	2423 2424 2443 2444 2473 2474
2/2	2404 2405 2426 2427 2456 2457
2/3	2410 2411 2431 2432 2448 2449
2/4	2417 2418 2451 2452 2468 2469
2/5	2437 2438 2462 2463 2477 2478

Group 3: Channels 1-8 (latency = 7.3 ms)

Group/Channel	Frequencies
3/1	2415 2416 2443
3/2	2422 2423 2439
3/3	2426 2427 2457
3/4	2447 2448 2468
3/5	2409 2451 2452
3/6	2431 2462 2463
3/7	2404 2473 2474
3/8	2435 2477 2478

Group 4: Channel 1 (latency = 7.3 ms)

Group/Channel	Frequencies
4/1	2404 2405 2410 2411 2417 2418 2423 2424 2426 2427 2431 2432 2437 2438 2443 2444 2448 2449 2451 2452 2456 2457 2462 2463 2468 2469 2473 2474 2477 2478

Firmware

Firmware is embedded software in each component that controls functionality. Periodically, new versions of firmware are developed to incorporate additional features and enhancements. To take advantage of design improvements, new versions of the firmware can be downloaded and installed using the Shure Update Utility tool.

Software is available for download from <http://www.shure.com/update-utility>.

Connect to the Computer

Connect the device to your computer using the USB to Micro USB cable supplied with your GLX-D system.

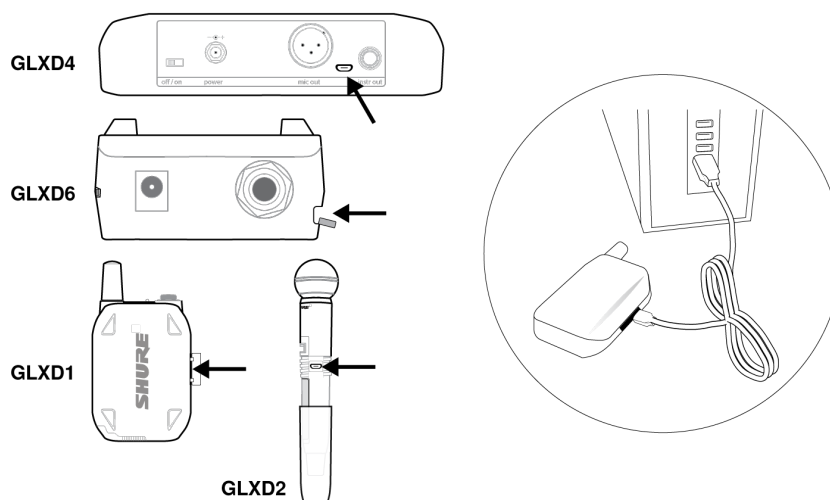

Operation

Gain Adjustment

Use the gain buttons on the receiver to increase or decrease the gain of a linked transmitter:

- Turn on the linked transmitter and momentarily press the gain buttons to adjust the gain in 1 dB increments
- For faster gain adjustments, press and hold the gain buttons

Tip: Monitor the audio and observe the receiver audio meter level while adjusting the gain to prevent signal overload.

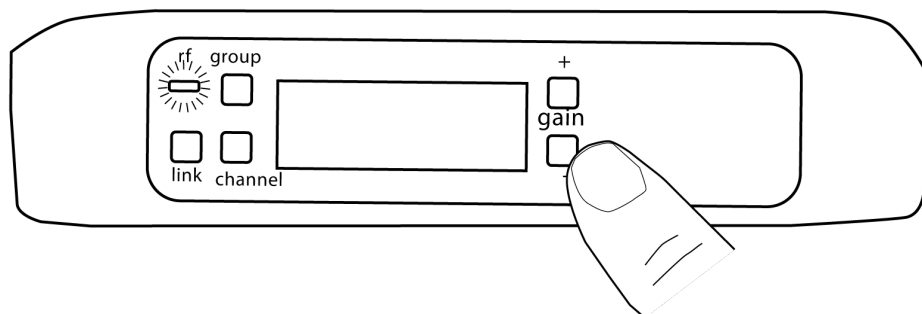

Locking and Unlocking the Controls

The controls of the receiver and transmitter can be locked to prevent accidental or unauthorized changes to settings.

Note: Locks are not affected by power cycles.

Locking the Receiver Controls

Simultaneously press and hold the group and channel buttons until LK appears on the LCD. Repeat to unlock.

- LK is displayed if a locked control is pressed
- UN is displayed momentarily to confirm the unlock command

Locking the Transmitter Power Switch

Starting with the transmitter set to off, press and hold the LINK button while turning on the transmitter. Continue to hold the link button until the lock icon appears on the receiver LCD. Repeat sequence to unlock.



Optionally, the transmitter power switch can be remotely locked from the receiver front panel:

Simultaneously press and hold the group and link buttons for approximately 2 seconds until the flashing lock icon appears on the receiver LCD. Repeat sequence to unlock.

Identifying Linked Transmitters and Receivers with Remote ID

Use the Remote ID feature to identify linked transmitter and receiver pairs in multiple receiver systems. When Remote ID is active, the receiver LCD will blink and display ID. The status LED of the corresponding transmitter will alternately flash red and green for approximately 45 seconds.

To activate Remote ID:

1. Momentarily press the link button on the transmitter or receiver.
2. The LCD of the linked receiver will blink and display ID and the status LED on the linked transmitter will flash red/green.
3. To exit Remote ID mode, momentarily press the link button or allow the function to timeout.

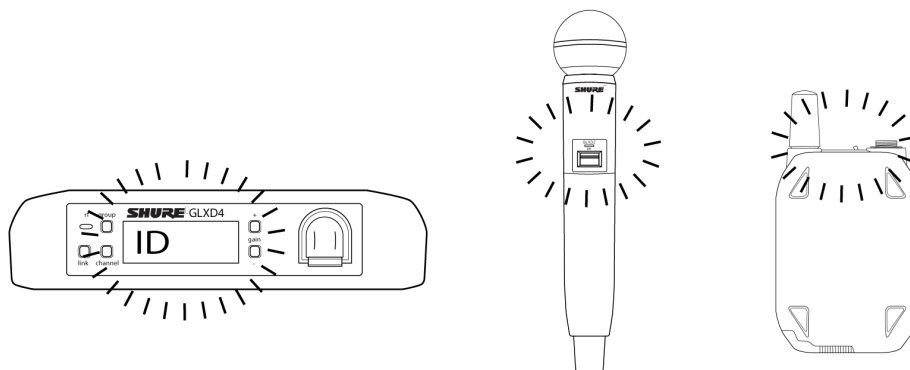

Manually Selecting a Group and Channel

Specific groups and channels can be assigned to the receiver instead of using the automatic scan function.

Note: Group 3 should only be used in controlled Wi-Fi environments to prevent interference from unexpected Wi-Fi devices.

Selecting a Group

1. Press and hold the group button for 2 seconds until the group display flashes.
2. Press the group button to scroll through the available groups.
3. The receiver will automatically save the selected group.

Selecting a Channel

1. Press and hold the channel button for 2 seconds until the channel display flashes.
2. Press the channel button to scroll through the available channels.
3. The receiver will automatically save the selected channel.

Note: A double dash symbol-- displayed on the receiver screen during a channel scan indicates that there are no available channels within the selected group. Choose a group with more channels and repeat set up steps.

Troubleshooting

Issue	Indicator Status	Solution
No sound or faint sound	Receiver RF LED on	Verify all sound system connections or adjust gain as needed (see Adjusting Gain). Verify that the receiver is connected to mixer/amplifier.
	Receiver RF LED off	Turn on transmitter. Make sure the batteries are installed correctly. Link transmitter and receiver (see Linking topic). Charge or change transmitter battery.
	Receiver LCD screen off	Make sure AC adapter is securely plugged into electrical outlet. Make sure receiver is powered on.
	Transmitter indicator LED flashing red	Charge or change transmitter battery.
	Transmitter plugged into charger.	Disconnect transmitter from charger.
Audio artifacts or dropouts	rf LED flickering or off	Change receiver and transmitter to a different group and/or channel.

Issue	Indicator Status		Solution
			Identify nearby sources of interference (cell phones, Wi-Fi access points, signal processor, etc...) and shutdown or remove source. Charge or change transmitter battery. Ensure that receiver and transmitter are positioned within system parameters. System must be set up within recommended range and receiver kept away from metallic surfaces. Transmitter must be used in line of sight from receiver for optimal sound.
Distortion	OL indicator appears on receiver LCD		Reduce transmitter gain (see Gain Adjustment).
Transmitter and receiver link unsuccessful	Transmitter and receiver LEDs flash to indicate that linking started, but the link fails		Update both components to firmware version 2.0 or greater. Download the Shure Update Utility application and follow the instructions.
Sound level variations when switching to different sources	N/A		Adjust transmitter gain as necessary (see Gain Adjustment).
Receiver/transmitter won't turn off	Transmitter LED flashing rapidly		Controls locked. See Locking and Unlocking Controls.
Receiver gain control cannot be adjusted	N/A		Check transmitter. Transmitter must be on to enable gain changes.
Receiver controls cannot be adjusted	LK shown on receiver display when buttons are pressed		Controls locked. See Locking and Unlocking Controls.
Transmitter ID function does not respond	Transmitter LED flashes green 3 times		Controls locked. See Locking and Unlocking Controls.
Transmitter information does not appear on the Receiver LCD	N/A		Linked transmitter is off or the receiver is not linked to a transmitter.
Transmitter powers off after 1 hour	Transmitter status LED off		GLX-D transmitters automatically power-off after 1 hour to conserve battery life if the signal from a linked receiver is not detected. Make sure that linked receiver is turned on.
SB902A battery will not charge in GLXD1 bodypack transmitter	Rapid flashing green LED on GLXD1		Charge battery once in GLXD4 receiver or SBC-902 charger. Subsequent recharging can occur in GLXD1 bodypack.
Model	A	B	C
SM58	51 mm, 2.0 in.	252 mm, 9.9 in.	37 mm, 1.5 in.
BETA 58	51 mm, 2.0 in.	252 mm, 9.9 in.	37 mm, 1.5 in.

Model	A	B	C
SM86	49 mm, 1.9 in.	252 mm, 9.9 in.	37 mm, 1.5 in.
BETA 87A	51 mm, 2.0 in.	252 mm, 9.9 in.	37 mm, 1.5 in.

Resetting Components

Use the reset function if it is necessary to restore the transmitter or receiver to their factory settings.

Resetting the Receiver

Restores the receiver to the following factory settings:

- Gain level = default
- Controls = unlocked

Press and hold the link button while turning on the receiver power until the LCD displays RE.

Note: When reset is complete, the receiver will automatically initiate linking to search for a transmitter. Press and hold the transmitter link button within five seconds of powering-on to complete the link.

Resetting the Transmitter

Restores the transmitter to the following factory settings:

- Controls = unlocked

Press and hold the transmitter link button while turning on the transmitter until power LED goes off.

When the link button is released, the transmitter will automatically initiate linking to find an available receiver. Press the link button on an available receiver to relink.

Specifications

Tuning Bandwidth

2400–2483.5 MHz

Working Range

Indoor	Up to 30 m (100 ft) typical, Up to 60 m (200 ft) maximum
Outdoor	Up to 20 m (65 ft) typical, Up to 50 m (165 ft) maximum

Transmit Mode

Shure proprietary digital

Audio Frequency Response

20 Hz– 20 kHz

Dynamic Range

120 dB, A-weighted

RF Sensitivity

-88 dBm, typical

Total Harmonic Distortion

0.2%, typical

RF Output Power

10 mW E.I.R.P. max

Operating Temperature Range

-18°C (0°F) to 57°C (135°F)

Storage Temperature Range

-29°C (-20°F) to 74°C (165°F)

Polarity

Positive voltage applied to the tip of the guitar cable phone plug produces positive voltage at the tip of the high impedance ¼-inch output.

Battery Life

Up to 11.5 hours

Guitar Tuner

Tuning Accuracy	±1 cent
Tuning Range	F#0 to C8

Channel Count

4 typical, Up to 8 maximum

GLXD1**Dimensions**

90 x 65 x 23 mm (3.56 x 2.54 x 0.90 in.), H x W x D (without antenna)

Weight

132 g (4.7 oz.) without batteries

Power Requirements

3.7 V

Rechargeable Li-Ion

Housing

Cast Metal, Black Powdercoat

Input Impedance900 k Ω **RF Output Power**

10 mW E.I.R.P. max

Transmitter Input**Connector**

4-Pin male mini connector (TA4M)

Configuration

Unbalanced

Maximum Input Level*1 kHz at 1% THD*

+8.4 dBV (7.5 Vp-p)

Antenna Type

Internal Monopole

Pin Assignments*TA4M*

1	ground (cable shield)
2	+ 5 V Bias
3	audio
4	Tied through active load to ground (On instrument adapter cable, pin 4 floats)

Pin Assignments*TA4M*

1	ground (cable shield)
2	+ 5 V Bias
3	audio
4	Tied through active load to ground (On instrument adapter cable, pin 4 floats)

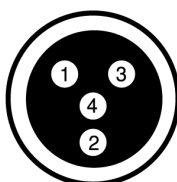

TA4M Connector

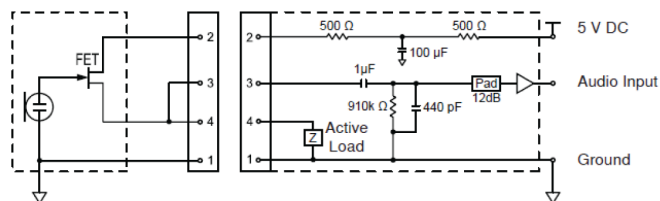

Weight

SM58	267 g (9.4 oz.) without batteries
BETA 58	221 g (7.8 oz.) without batteries
SM86	275 g (9.1 oz.) without batteries
BETA 87A	264 g (9.3 oz.) without batteries

Housing

Molded Plastic

Power Requirements

3.7 V

Rechargeable Li-Ion

RF Output Power

10 mW E.I.R.P. max

Maximum Input Level

SM58	146 dB SPL
BETA 58	147 dB SPL
SM86	143 dB SPL
BETA 87A	147 dB SPL

Dimensions

Model	A	B	C
SM58	51 mm, (2.0 in.)	252 mm, (9.9 in.)	37 mm, (1.5 in.)
BETA 58	51 mm, (2.0 in.)	252 mm, (9.9 in.)	37 mm, (1.5 in.)
SM86	49 mm, (1.9 in.)	252 mm, (9.9 in.)	37 mm, (1.5 in.)
BETA 87A	51 mm, (2.0 in.)	252 mm, (9.9 in.)	37 mm, (1.5 in.)

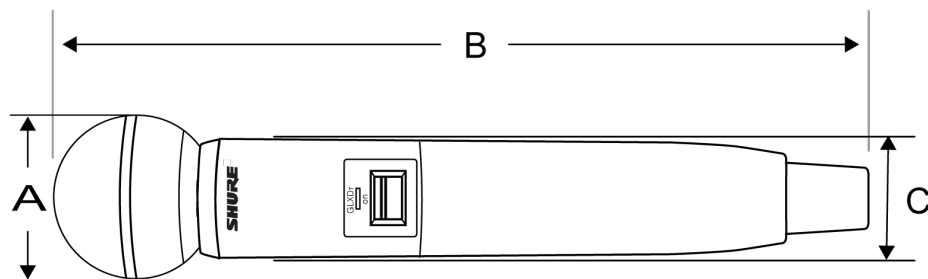

Dimensions

40 x 183 x 117 mm (1.6 x 7.2 x 4.6 in.), H x W x D

Weight

286 g (10.1 oz.) without batteries

Housing

Molded Plastic

Power Requirements

14 to 18 V DC (Tip positive with respect to ring), 550 mA

Spurious Rejection

>35 dB, typical

Gain Adjustment Range

-20 to 40 dB in 1 dB steps

Phantom Power Protection

Yes

Tuning Bandwidth

2400–2483.5 MHz

Working Range

Indoor	Up to 30 m (100 ft) typical, Up to 60 m (200 ft) maximum
Outdoor	Up to 20 m (65 ft) typical, Up to 50 m (165 ft) maximum

Transmit Mode

Frequency Hopping

Audio Frequency Response

20 Hz– 20 kHz

Dynamic Range

120 dB, A-weighted

RF Sensitivity

-88 dBm, typical

Total Harmonic Distortion

0.2%, typical

RF Output Power

10 mW E.I.R.P. max

Operating Temperature Range

-18°C (0°F) to 57°C (135°F)

Storage Temperature Range

-29°C (-20°F) to 74°C (165°F)

Polarity

Positive pressure on microphone diaphragm (or positive voltage applied to tip of WA302 phone plug) produces positive voltage on pin 2 (with respect to pin 3 of low-impedance output) and the tip of the high impedance 1/4-inch output.

Battery Life

Up to 16 hours

Channel Count

4 typical, Up to 8 maximum

Audio Output**Configuration**

XLR Output	Impedance balanced
6.35 mm (1/4") output	Impedance balanced

Impedance

XLR Output	100 Ω
6.35 mm (1/4") output	100 Ω (50 Ω , Unbalanced)

Maximum Audio Output Level

XLR connector (into 600 Ω load)	+1 dBV
6.35 mm (1/4") connector (into 3 kΩ load)	+8.5 dBV

Pin Assignments

XLR Output	1=ground, 2=hot, 3=cold
-------------------	-------------------------

6.35 mm (1/4") connector

Tip=audio, Ring=no audio, Sleeve=ground

Receiver Antenna Input

Impedance

50 Ω

Antenna Type

½ Wave Sleeve Dipole, non-removable

Maximum Input Level

-20 dBm

Certifications

This device complies with part 15 of the FCC Rules. Operation is subject to the following two conditions: (1) This device may not cause harmful interference, and (2) this device must accept any interference received, including interference that may cause undesired operation.

This wireless system operates in the globally available ISM band 2400 MHz to 2483.5 MHz. The operation does not require a user license.

Certified by ISED in Canada under RSS-210 and RSS-GEN.

IC: 616A-GLXD1, 616A-GLXD2, 616A-GLXD4

Certified under FCC Part 15.

FCC ID: DD4GLXD1, DD4GLXD2, DD4GLXD4

Industry Canada ICES-003 Compliance Label: CAN ICES-3 (B)/NMB-3(B)

This device contains licence-exempt transmitter(s)/receiver(s) that comply with Innovation, Science and Economic Development Canada's licence-exempt RSS(s). Operation is subject to the following two conditions:

1. This device may not cause interference.
2. This device must accept any interference, including interference that may cause undesired operation of the device.

L'émetteur/récepteur exempt de licence contenu dans le présent appareil est conforme aux CNR d'Innovation, Sciences et Développement économique Canada applicables aux appareils radio exempts de licence. L'exploitation est autorisée aux deux conditions suivantes :

1. L'appareil ne doit pas produire de brouillage;
2. L'appareil doit accepter tout brouillage radioélectrique subi, même si le brouillage est susceptible d'en compromettre le fonctionnement.

Meets essential requirements of the following European Directives:

- WEEE Directive 2012/19/EU, as amended by 2008/34/EC
- RoHS Directive EU 2015/863

Note: Please follow your regional recycling scheme for batteries and electronic waste

This product meets the Essential Requirements of all relevant European directives and is eligible for CE marking.

Hereby, Shure Incorporated declares that the radio equipment is in compliance with Directive 2014/53/EU. The full text of the EU declaration of conformity is available at the following internet address: <http://www.shure.com/europe/compliance>

Authorized European representative:
 Shure Europe GmbH
 Headquarters Europe, Middle East & Africa
 Department: EMEA Approval
 Jakob-Dieffenbacher-Str. 12
 75031 Eppingen, Germany
 Phone: +49-7262-92 49 0
 Fax: +49-7262-92 49 11 4
 Email: EMEAsupport@shure.de

運用に際しての注意

この機器の使用周波数帯では、電子レンジ等の産業・科学・医療用機器のほか工場の製造ライン等で使用されている移動体識別用の構内無線局（免許を要する無線局）及び特定小電力無線局（免許を要しない無線局）並びにアマチュア無線局（免許を要する無線局）が運用されています。

1. この機器を使用する前に、近くで移動体識別用の構内無線局及び特定小電力無線局並びにアマチュア無線局が運用されていないことを確認して下さい。
2. 万一、この機器から移動体識別用の構内無線局に対して有害な電波干渉の事例が発生した場合には、速やかに使用周波数を変更するか又は電波の発射を停止した上、下記連絡先にご連絡頂き、混信回避のための処置等（例えば、パーティションの設置など）についてご相談して下さい。
3. その他、この機器から移動体識別用の特定小電力無線局あるいはアマチュア無線局に対して有害な電波干渉の事例が発生した場合など何かお困りのことが起きたときは、保証書に記載の販売代理店または購入店へお問い合わせください。代理店および販売店情報は Shure 日本語ウェブサイト <http://www.shure.co.jp> でもご覧いただけます。

現品表示記号について

2.4 XX 8

現品表示記号は、以下のことを表しています。この無線機器は 2.4GHz 帯の電波を使用し、変調方式は「その他」の方式、想定干渉距離は 80m です。2,400MHz ~ 2,483.5MHz の全帯域を使用し、移動体識別装置の帯域を回避することはできません。

Information to the user

This device complies with part 15 of the FCC Rules. Operation is subject to the following two conditions:

1. This device may not cause harmful interference.
2. This device must accept any interference received, including interference that may cause undesired operation.

Note: This equipment has been tested and found to comply with the limits for a Class B digital device, pursuant to part 15 of the FCC Rules. These limits are designed to provide reasonable protection against harmful interference in a residential installation. This equipment generates uses and can radiate radio frequency energy and, if not installed and used in accordance with the instructions, may cause harmful interference to radio communications. However, there is no guarantee that interference will not occur in a particular installation. If this equipment does cause harmful interference to radio or television reception, which can be determined by turning the equipment off and on, the user is encouraged to try to correct the interference by one or more of the following measures:

- Reorient or relocate the receiving antenna.
- Increase the separation between the equipment and the receiver.
- Connect the equipment to an outlet on a circuit different from that to which the receiver is connected.

- Consult the dealer or an experienced radio/TV technician for help.