

B-Questa®

BIK®
Best Sound System from Japan

OWNER'S MANUAL 使用说明书

BMS-5015

Portable Speaker System
便携式扬声器系统

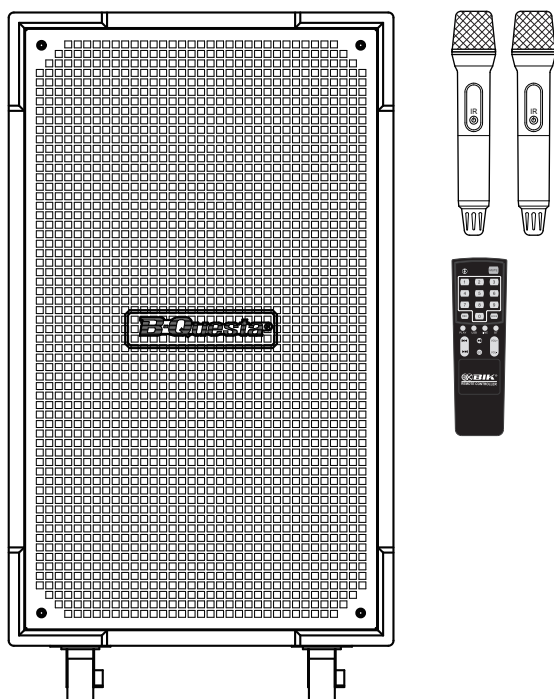

Thank you for purchasing our Portable Speaker System.

Please read the owner's manual thoroughly prior to using the system in order for you to make it use with safety and at the best function.

Please keep the manual for future reference.

感谢您购买本公司的便携式扬声器。



为了尽快地熟悉掌握本产品的各项功能，使用前请先阅读本说明书。

阅读完后，请注意妥善保管。

| | | | | | |
|-----------------|--------------------------|---|----------------------|-----------------------|---|
| CONTENTS | CAUTION FOR SAFETY | 2 | BATTERY CHARGING AND | BASIC OPERATION | 5 |
| | FUNCTION AND NAME | 3 | EXTERNAL BATTERY | ANY TROUBLES ? | 6 |
| | CONNECTION | 4 | CONNECTION | SPECIFICATIONS | 6 |

CAUTION FOR SAFETY

This "Caution for safety" shows various kinds of pictures in order to be used safely and correctly and to prevent from damaging other people, and their property. Please read with full understanding, and carefulness.

| | |
|--|---|
|  WARNING | This shows: Using this product with disregarding cautions might call for death or injury. |
|  CAUTION | This shows: Using this product with disregarding cautions might call for people to be harmed and goods to be damaged. |

[Examples of pictures show]







△ Indicates cautions inclusive warnings.





⊘ Indicators prohibition for action. Detail contents of prohibition are shown in the pictures (Pictures on left tells you not to re-assemble.)



● Shows indication of full contents and action to be done.
A concrete content (picture on left) tells :power supply plug to be taken out of outlet.

|  WARNING | |
|--|---|
| <ul style="list-style-type: none"> ● Making use of this product under the circumstances that a smoke, an abnormal smell, an irregular sound come out, it may cause a fire and an electric shock. In this case, switch off the product, and take power supply plug out of the outlet right away. Bring it to the shop for repair. ● In case when water or foreign substances get into product, switch off right away, and take power supply plug out of outlet, and consult with the repair shop, other wise, it may cause a fire or an electric shock. ● In case when product is dropped, switch off right away, and take power supply plug out of outlet, and consult with the repair shop, otherwise, it may cause a fire or an electric shock. | <p>WARNING</p>  <p>The power supply plug is pulled out from the outlet</p> |
| <ul style="list-style-type: none"> ● Re-assembling this product is highly prohibited, otherwise, it may cause a fire or an electric shock. ● Do not take amplifier out, otherwise, it may cause an electric shock. Inspection, repair should be done in the repair shop. |  <p>Decomposition prohibition</p> |
| <ul style="list-style-type: none"> ● This product can no way be used in the bathroom, otherwise, it may cause a fire, or an electric shock. ● Pay attention not for water to go into or get wet. Or it may cause a fire or an electric shock. |  <p>Use prohibition in water scene</p> |
| <ul style="list-style-type: none"> ● Do not use this product with a voltage other than indicated, or it may cause a fire, or an electric shock. ● This product can be only used with AC power supply, which 220 - 240V 50Hz, or DC 12V power supply. ● This product is not designed for built-in installation : do not place the product in an enclosed place such as a bookcase or rack. ● Be careful for power supply plug, or outlet not to get dust or to get it wet, or it may cause a fire. ● Do not put metal or flammable substances into this product, or it may cause a fire or an electric shock. ● Do not put any containers with water, or small metal substances near or on this product, or it may cause a fire, or an electric shock, and it becomes out of order. |  <p>PROHIBITION</p> |

|  CAUTION | |
|---|--|
| <ul style="list-style-type: none"> ● When this product is not used for a longer period, power supply plug should be taken out of outlet. ● In case the thunder is generated near-by, take power supply plug out of outlet right away, or it may cause a fire or an electric shock. ● If this product needs to be moved, switch off first, and then take power supply plug out, or it may damage cord, and may cause a fire or an electric shock. |  <p>The power supply plug is pulled out from the outlet</p> |
| <ul style="list-style-type: none"> ● Do not put this product near cooking counter or damp supply outlet, or it may cause a fire or an electric shock. ● Do not put this product on unstable desk, it may cause damage or injury when dropped. ● Do not allow to come to heating equipment, or it may melt code surface and cause a fire or an electric shock. ● Do not leave this product for a longer period such as in the cars where all windows are shut, or place where direct sunshine hits. Or it may damage each part of this product, and may cause a fire. ● Do not plug in or plug out with wet hands, or it may cause an electric shock. ● When taking power supply plug out, do not pull out cord, or it may damage cord, and cause a fire or an electric shock. Grip plug itself when taking out of outlet. ● If the built-in battery is fully charged and the battery life is significantly reduced, it is time to replace the battery. Contact the repair shop before replacing the battery. |  <p>CAUTION</p> |

FUNCTION AND NAME

Amplifier operational panel

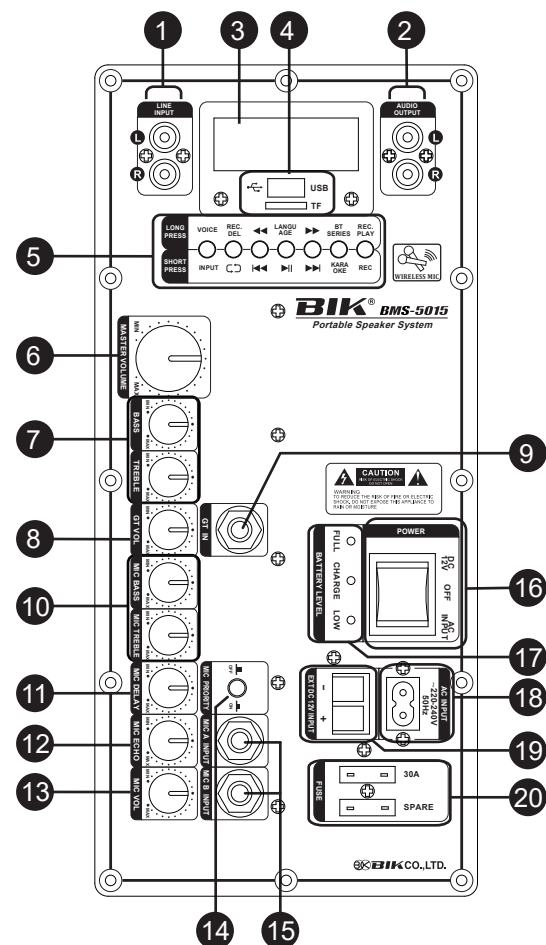

1 LINE INPUT
Audio input.

2 AUDIO OUTPUT
Audio output.

3 DISPLAY
To show the operate mode.

4 USB / TF port
To insert USB / TF CARD.

5 CONTROL BUTTONS
SHORT PRESS

INPUT : To select the input in the order of BLUE, LINE, USB, CARD. When the BT connection is completed, the blinking "BLUE" display changes to lit. (BT device name of this product is "BMS-5015")

↻ : To switch the repeate of one or all songs.

⏮ : Reverse

⏸ : Pause, Play.

⏭ : Forward

Karaoke : To set to KARAOKE mode.

REC : To record of MIC input.

LONG PRESS

VOICE : To make Voice or not.

REC. DEL : To delete recording.

⏮ : Rewind.

LANGUAGE : To select Chinese or English.

⏭ : Fast Forward.

BT SERIES : You can operate two of these products as STEREO by making a BT connection according to the following procedure.

1. If the power of this product is on, turn off the power of both products.
2. If the device name "BMS-5015" already exists on the Bluetooth transmitter, delete the device name "BMS-5015".
3. Turn on the power of the two products.
4. Long press "BT SERIES" button (the display "SLAU" flashes).
5. The other product selects the input signal as "BLUE" and waits (the display "BLUE" flashes).
6. Select the device name "BMS-5015" of this product on the Bluetooth transmitter side.
7. The connection is successful after a few seconds. (When the connection is completed, the "BLUE" and "SLAU" displays will change from blinking to lit.)

*The "BLUE" display side operates as Lch, and the "SLAU" display side operates as Rch.

REC.PLAY : To play the recorded content of USB or TF card.

6 MASTER VOLUME

To adjust Music volume.

7 Music Tone Control Volumes

To adjust Tone of Bass and Treble.

8 GT VOL

To adjust the Guitar volume.

9 GT IN

Guitar input.

10 MIC Tone Control Volumes

To adjust Tone of Bass and Treble of all MIC.

11 MIC DELAY

To adjust the Delay time of Echo of all MIC.

12 MIC ECHO

To adjust the level of Echo of all MIC.

13 MIC VOL

To adjust the level of all MIC.

14 MIC PRIORITY BUTTON

To reduce other music, when MIC voice is input.

15 MIC INPUT

MIC A and MIC B are connected in parallel.

16 POWER Switch

OFF : Power OFF

DC 12V : To drive by Battery power.

AC INPUT : To drive by AC power.

17 BATTERY LEVEL

Battery status display.

18 AC INPUT

Power input AC220 - 240V / 50Hz.

19 EXT DC 12V INPUT

External battery input DC12V.

20 FUSE

30A protective fuses and 30A spare fuses.

REMOTE CONTROLLER

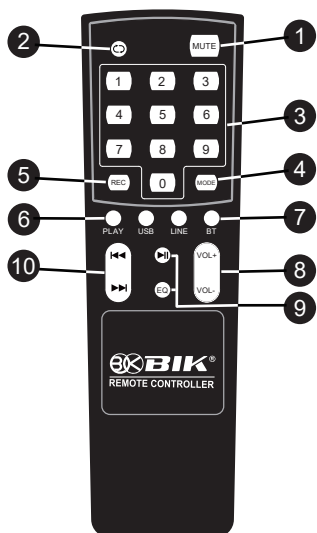

- ① MUTE Button
- ② Repeat Button : To select ONE or ALL repeat.
- ③ Select track Button : Select the track number directly with numbers.(For USB and TF CARD only.)
- ④ MODE Button : To select input, BLUETOOTH or LINE or USB or TF CARD. To make Voice or not. (Push the “MODE” button for more than 2 second.)
- ⑤ REC Button : Recording of MIC input.
- ⑥ PLAY Button : To play recorded contents. For deleting recorded contents, push the “PLAY” button for more than 2 seconds.
- ⑦ USB, LINE, BT Button : To select USB or LINE or BLUETOOTH directly.
- ⑧ VOL +, VOL - Button : To adjust music volume.
- ⑨ Pause Button : To pause BLUETOOTH, USB, or TF CARD. To select Chinese or English. (Push the “” button for more than 2 second.)
- EQ Button : To select POP, ROCK, JASS, CLASSIC, or FLAT.
- ⑩ Reverse Forward Button : “” Reverse.“” Forward.

WIRELESS MICROPHONE

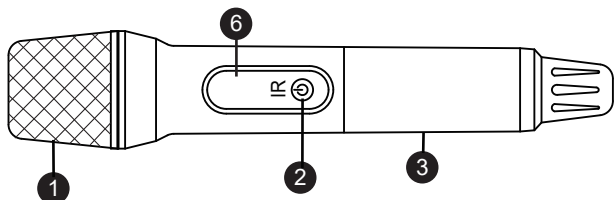

- ① Microphone head case
- ② Power Switch / Channel setting / Level setting
- ③ Grip
- ④ Battery case for Lithium ion battery (18650).
- ⑤ AA battery case.
- ⑥ Display

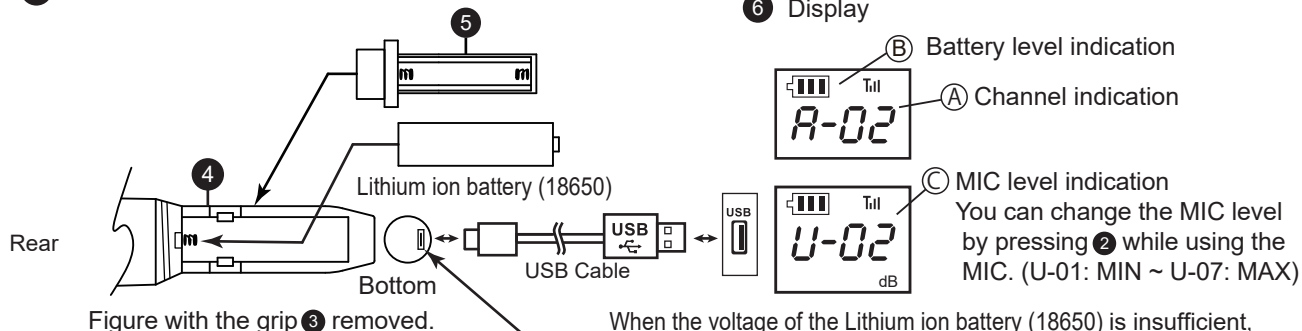

● How to set Channel (Frequency)

1. Put a microphone to near the amplifier panel.
2. With MIC OFF, press and hold ② (about 5 seconds) to display “SEL”.
3. You can change the channel by pressing ② after displaying “SEL”.

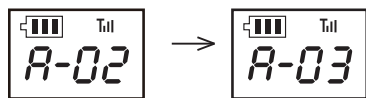

MIC A: 01 - 50 CH
MIC B: 51 - 100 CH

4. Automatically connects wirelessly with Amplifier after selecting a channel.

CONNECTION

1. How to connect to audio output of music source.

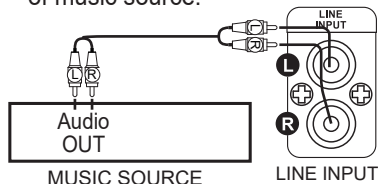

2. How to connect to audio input of amplifier.

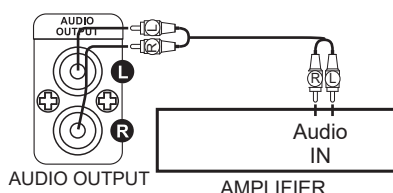

3. How to connect to Guitar and Microphones.

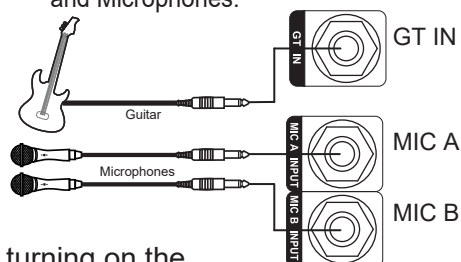

(IMPORTANT)

Do not turn on the power until all connections are completed. When turning on the power, turn on the power of the external Amplifier last. When turning off the power, turn off the power of the external Amplifier first.

BATTERY CHARGING AND EXTERNAL BATTERY CONNECTION

Please fully charge the battery before using this product for the first time.

1. How to charge the built-in battery.

When you connect this product to an “AC OUTLET” with a “Power Cable” , the "CHARGE" LED (RED) lights up and charging starts. (See the figure below)

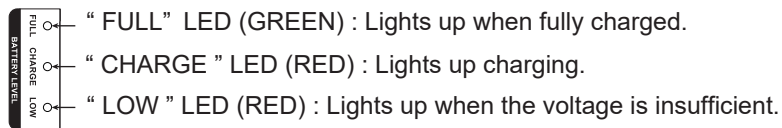
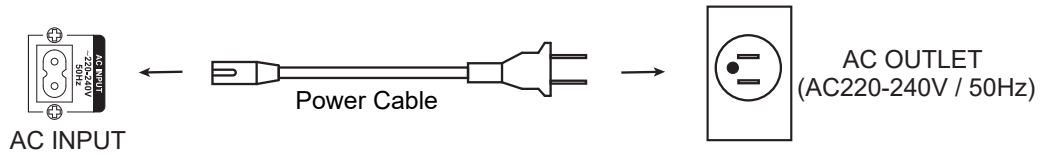

BATTERY LEVEL Indicator

2. How to connect an external battery.

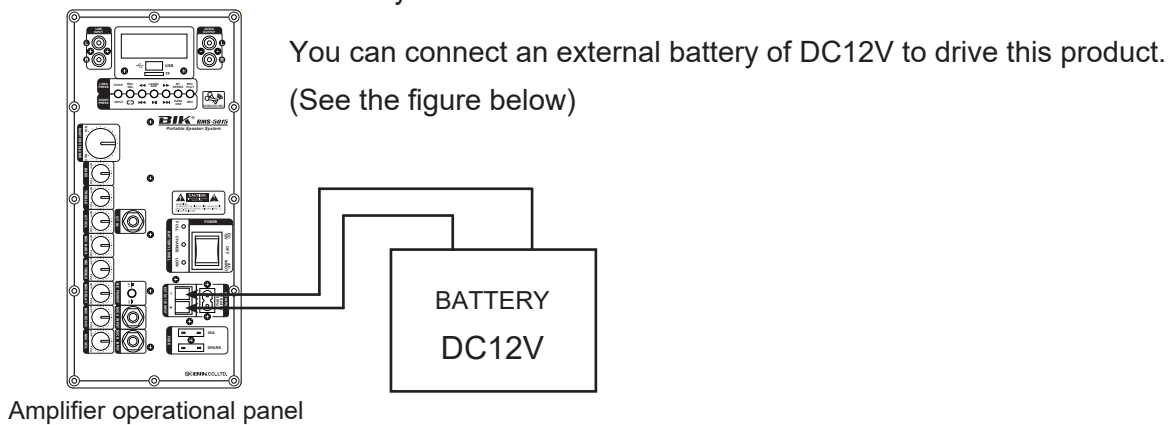

BASIC OPERATION

1. Be sure to lock the two casters 21 when using.

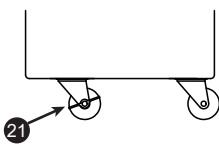

2. Connect this product 18 to an “AC OUTLET” with a “Power Cable”.
3. POWER Switch 16 ON.
4. Press the INPUT button 5 to select input.
5. Adjust “MASTER VOLUME” knob 6 at your required volume.
6. When using a microphone, please use the microphone holders 22.

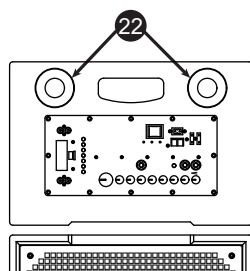

TOP View

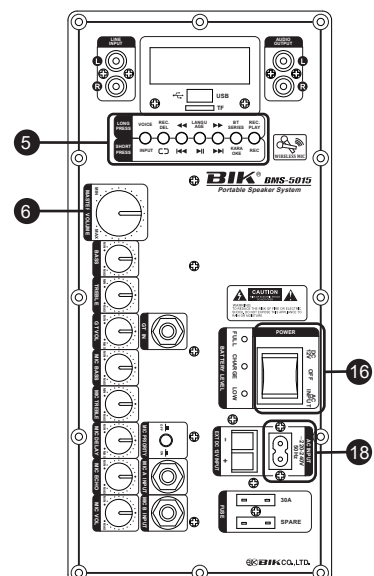

ANY TROUBLES?

Any troubles? Please check the followings. Your careless mistakes seem to be troubles. Consult with your dealers in case any troubles can not be solved after checking the followings.

| Trouble | Cause | Remedy |
|--|--|---|
| Not turned on | <ul style="list-style-type: none"> ● Not plugged in ● Battery voltage drop | <ul style="list-style-type: none"> ● Plug cord in ● Charge Battery |
| No sound produced even music starts in "On position" | <ul style="list-style-type: none"> ● Volume is set at minimum position ● Input signal wires in poor or not connected correctly | <ul style="list-style-type: none"> ● Set volume at your required position ● Re-connect once again |
| Noisy | <ul style="list-style-type: none"> ● Battery voltage drop | <ul style="list-style-type: none"> ● Plug in the power cable |

SPECIFICATIONS

Amplifier

| | |
|----------------------------|-----------------------------|
| Maximum Output Power | 220W / 4Ω |
| Frequency Response | 20Hz - 20kHz |
| LINE INPUT | 200mV |
| MIC INPUT | 20mV |
| GUITAR INPUT | 20mV |
| AUDIO OUTPUT | 5V |
| BATTERY Part Number | 6 - DZF-20. 2 (12V 20. 2Ah) |

Speaker

| | |
|---------------|-----------------|
| Woofer | 380mm Cone Type |
| Tweeter | Horn Type |

Wireless Microphone

| | |
|---------------------------|---|
| Voltage | DC3. 7V - 4. 2V (Lithium ion battery 1 piece) |
| Operating current | 80mA (MIN) |
| Continuous use time | About 8 -10H (Depends on battery capacity) |
| Frequency | UHF Frequency conversion / 740. 3 - 805. 3MHz |
| Channel | MIC A : 740. 3 - 755. 3MHz (01 - 50CH) MIC B : 790. 3 - 805. 3MHz (51 - 100CH) |
| Dynamic range | 105 dB (MIN) |
| Frequency response | 40Hz - 15kHz |
| Microphone Type | Dynamic Type / Unidirectional |

Power Supply, Others

| | |
|------------------------------|---------------------|
| Power Voltage | AC220 - 240V / 50Hz |
| | DC 12V |
| Power Consumption | 60 W |
| Dimensions (W x H x D) | 446 x 734 x 300mm |
| Weight | 30.9Kg |

Accessories

| | |
|--|------------------|
| Owner's manual | 1 |
| Power Cable | 1 |
| Remote Controller | 1 |
| Wireless Microphone | (MIC A, MIC B) 2 |
| USB Cable | 2 |
| AA battery case (For MIC A, MIC B) | 2 |

- Design and specifications subject to change without notice.

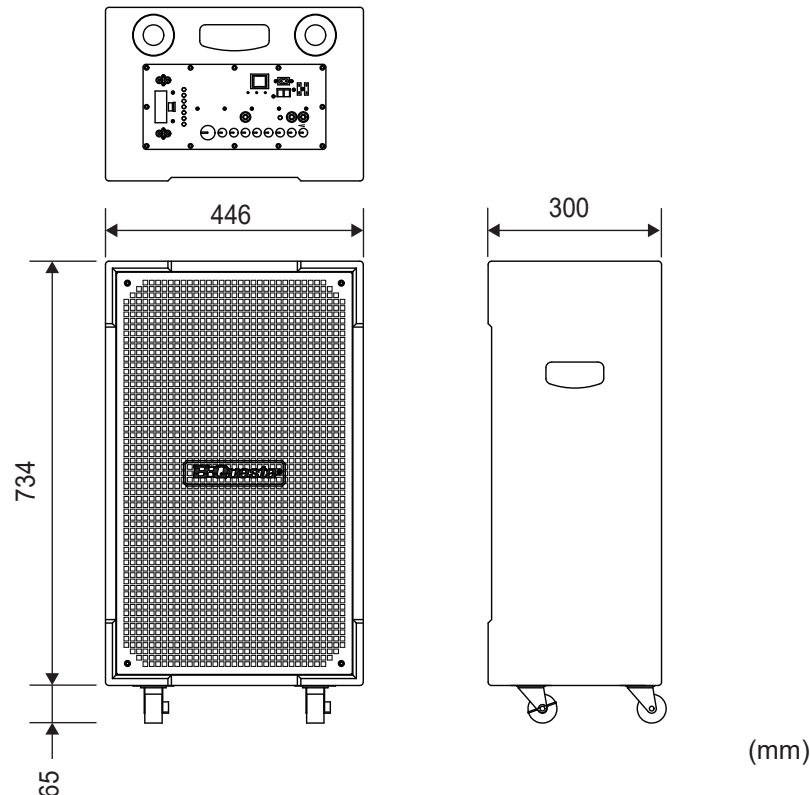

| | | | | | | |
|----|------------------|---|---------------------|----|------------|----|
| 目录 | 安全注意事项 | 7 | 电池充电及外接电池连接方法 | 10 | 产品规格 | 11 |
| | 各部分的功能及名称 | 8 | 操作方法 | 10 | | |
| | 各外接部分的连接方法 | 9 | 故障分析处理 | 11 | | |

安全注意事项

安全注意事项是为了安全正确使用本商品，防止给自己及他人带来财产损失。
以下用图标的形式加以注明。请仔细阅读本文。

| | | |
|--|-----------|-------------------------|
| | 警告 | 无视或误用会有造成人身事故的可能性。 |
| | 注意 | 无视或误用会有造成人身伤残，财产损失的可能性。 |

[图标表示的说明]

- △记号是表示注意（包括警告）的内容。
- ⊘记号是表示禁止内容。
具体的禁止内容注明在图标中（例：左图是表示禁止分解）。
- 记号是表示强制行为。
具体的指示内容注明在图标中（例：左图是表示拔下电源插头）。

| 警告 | |
|--|--|
| <ul style="list-style-type: none"> ● 在使用时，如果有冒烟、异味、异音等异常现象发生，为避免发生火灾，触电现象等，请立即切断本机电源，然后拔下电源插头。确认没有再冒烟后，到贩卖店进行修理。 ● 在使用时如有水或异物等混入机体内，首先切断机体电源，然后拔下电源插头。请尽快与贩卖店联系进行修理。在未进行维修的状态下使用，会引起火灾，触电等问题。 ● 在使用时如不慎掉落在地上造成损坏时，首先切断机体电源，然后拔下电源插头。请尽快与贩卖店联系进行修理。在未进行维修的状态下使用，会引起火灾，触电等事故。 | <p style="font-size: small;">警告</p> <small>从插座上拔下电源插头</small> |
| <ul style="list-style-type: none"> ● 请勿分解、改装本机器。会引起火灾、触电、故障等事故。 ● 绝对禁止私自拆解功率放大器，以免造成触电等事故。检测、修理等请交由贩卖店进行处理。 | <small>分解 禁止</small> |
| <ul style="list-style-type: none"> ● 请防止机器进水或使机器受潮，会引起火灾、触电等事故。 | <small>潮湿场所 禁止使用</small> |
| <ul style="list-style-type: none"> ● 请勿使用指定以外的电源电压。会引起火灾，触电等事故。 ● 本机器的电源电压使用范围AC220V - 240V，或DC12V。 ● 本产品的的设计是采用风扇强制排风散热，请勿将机器放置于密闭环境或不通风的地方。 ● 请不要用带有灰尘，潮湿的插头和插座，会引起火灾等事故。 ● 请注意不要将金属物品、或易燃物品插入机器中，以免引起火灾、触电等事故。 ● 请不要在机器上或附近放置装有液体的容器及金属物。 | <small>禁止</small> |

| 注意 | |
|---|-------------------------------|
| <ul style="list-style-type: none"> ● 旅行等长时间不使用时，为了安全请务必拔下电源插头。 ● 如近距离内有雷电现象时，请拔下电源插头，由于雷电原因，会引起火灾、触电、故障等事故。 ● 移动时，首先切断电源，然后务必拔下电源插头，再拆下其他接线。如电源线有损坏，会引起火灾、触电等事故。 | <small>从插座上拔下电源插头</small> |
| <ul style="list-style-type: none"> ● 请勿放置在灶台、加湿器及有油烟、雾气的地方。会引起火灾、触电等事故。 ● 请勿放置在不安稳的桌上、或倾斜的地方。会容易掉落、翻倒而造成损坏、损伤。 ● 请避免将电源线靠近过热的物品，以免电源线被熔化，而引起火灾、触电等事故。 ● 请勿放置在紧闭车窗的汽车内、或阳光直射及高温的地方。以免造成零部件的损坏，而引起火灾。 ● 请勿放置在潮湿、多灰尘的地方。以免引起火灾、触电等事故。 ● 请不要用潮湿的手拔、插电源插头。以免引起触电事故。 为了防止因电源线的损坏而引起火灾、触电等事故。在拔电源插头时，请务必握住电源插头后再拔下。 ● 如果内置电池的续航时间明显缩短的话，说明快到电池的使用寿命，应联系贩卖店更换电池。 | <small>注意</small> |

各部分的功能及名称

功放操作面板

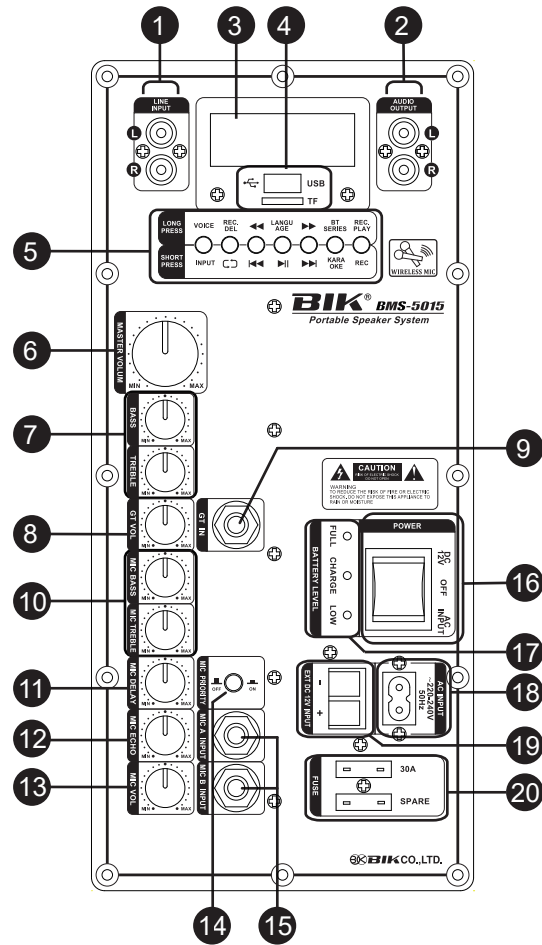

1 音频信号输入端子

2 音频信号输出端子

3 显示屏
显示实时操作状态

4 USB/TF储存卡端子

5 各功能操作按键
短按按键/SHORT PRESS
INPUT: 切换输入信号(蓝牙, 音频信号, U盘, 储存卡)
蓝牙连接成功后, 蓝牙显示不再闪烁。
(本产品的蓝牙设备名称为“BMS-5015”)

↻ : “ONE” 表示单曲循环。“ALL” 表示顺序循环。

⏮ : 上一首

⏸ : 暂停, 再按一次播放。

⏭ : 下一首

Karaoke : K歌模式

REC : 录音(只收录话筒的声音), 需插入USB/TF储存卡

长按按键/LONG PRESS

VOICE : 开启/关闭 语音提示

REC. DEL : 删除录制在USB/TF储存卡的录音内容。

⏪ : 快退

LANGUAGE : 切换中文/英文 语音提示

⏩ : 快进

BT SERIES : 2台音箱同时使用时可共享蓝牙信号。

按照以下的方法连接蓝牙后, 可同时用2只“BMS-5015”播放蓝牙信号音频, 从而达到立体声效果。

1. 首先开机, 确认2只“BMS-5015”的电源成功接通后, 关机。
2. 确认蓝牙信号发射设备, 如果显示配对过“BMS-5015”的话, 将其与“BMS-5015”的配对取消或删除。
3. 开机启动2只“BMS-5015”。
4. 长按其中一只音箱的“BT SERIES”按键 (显示屏上“SLAU”闪烁)。
5. 另一只音箱选择输入信号为蓝牙并等待 (显示屏上“BLUE”闪烁)。
6. 蓝牙信号发射设备上选择连接配对“BMS-5015”
7. 等待数秒后连接配对成功。(连接成功后显示屏上的“BLUE”和“SLAU”由闪烁变为长亮。)

※显示“BLUE”的音箱为左声道、显示“SLAU”的音箱为右声道。

REC.PLAY : 播放录音。(播放U盘, 储存卡的录音)

6 主音量旋钮

7 音乐音调控制旋钮 (调整音乐低音和高音电平)

8 吉他音量旋钮 (调节吉他音量)

9 吉他接口 (吉他信号输入接口)

10 麦克风音调控制旋钮 (调整麦克风低音和高音电平)

11 麦克风延迟旋钮 (调整麦克风延迟时间)

12 麦克风混响旋钮 (调节麦克风的混响大小)

13 麦克风音量旋钮 (调节麦克风声音大小)

14 麦克风优先按键
(开启后/ON, 使用麦克风时背景音量变小)

15 麦克风输入接口 (MIC A、MICB)

16 电源开关
OFF : 关机
DC 12V : 电池电源启动
AC INPUT : AC电源启动

17 电量显示 (详见P8)

18 AC电源输入接口 (AC220V to AC240V / 50Hz)

19 外部电池接口 (直流12V)

20 保护和备用保险丝 (30A)

遥控器

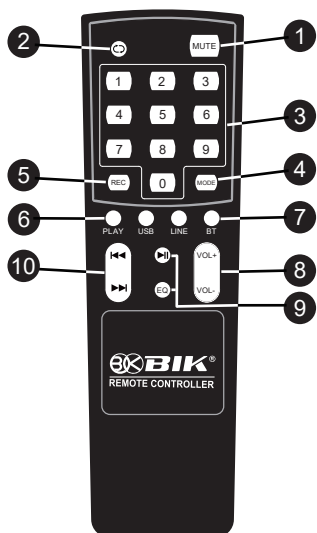

- ① 静音
- ② 循环播放 : 可选择单曲循环或顺序播放。
- ③ 选择歌曲: 输入U盘和储存卡中歌曲的对应顺序进行播放。
- ④ 音源信号选择: 选择输入的音源信号。(可切换蓝牙, LINE, USB, 储存卡)
长按2秒以上可开启/关闭换语音提示。
- ⑤ 录音: 录制话筒的声音。
- ⑥ 播放录音: 短按播放录音。长按2秒以上删除录音。
- ⑦ 切换USB, LINE, 蓝牙的输入信号
- ⑧ 调整音量
- ⑨ 暂停 : 暂停蓝牙, USB, 或者储存卡的音乐。
切换提示语言: 中文/英文(长按“”按键2秒以上)
切换效果: 可以选择POP(流行), ROCK(摇滚), JASS(爵士)
CLASSIC(经典) FLAT(原声)。
- ⑩ 上一曲/下一曲:
 上一曲 下一曲

无线麦克风

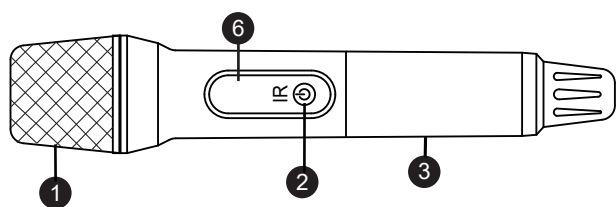

- ① 网头和音头模组
- ② 电源开关/频道设置/音量设置
- ③ 麦克风管体
- ④ 电池仓
- ⑤ AA电池盒
- ⑥ 显示屏

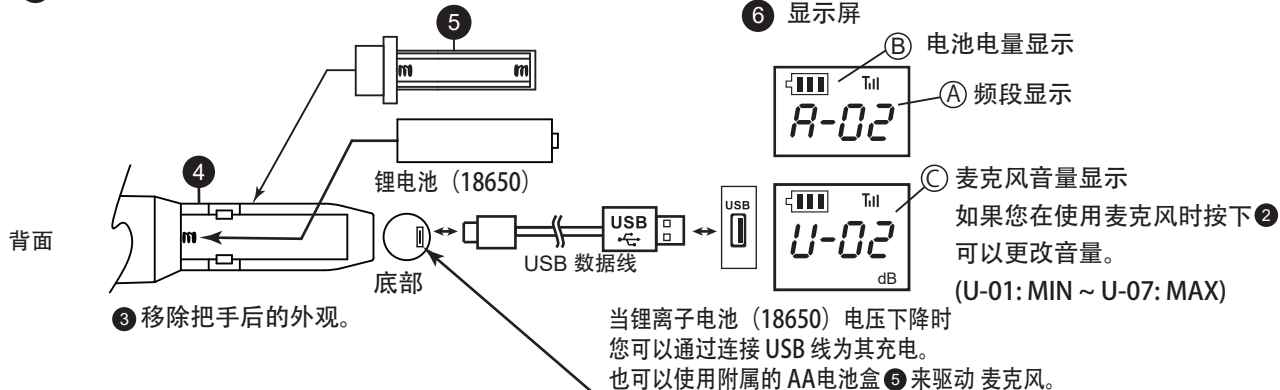

● 如何设置频道 (频率)

1. 将麦克风放在功放控制面板附近。
2. 先关闭麦克风再按住②约5秒钟, 将显示“SEL”。
3. 您可以在显示“SEL”后按②更改频道。



4. 完成频道设置后, 麦克风的无线连接自动完成。

各外接部分的连接方法

1. 如何连接音源信号

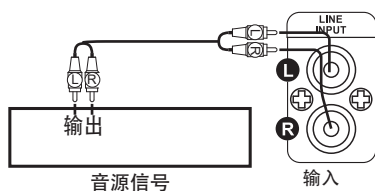

2. 如何将音频输出信号连接到外接功放

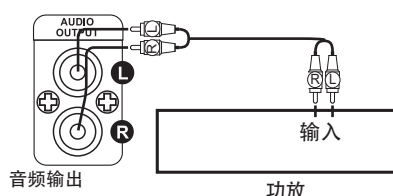

3. 如何连接吉他和麦克风

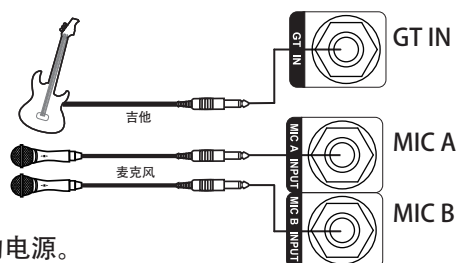

(重要)

在所有连接完成之前不要打开电源。当打开电源时, 最后再打开外接功放的电源。
关闭电源时, 请先关闭外接功放的电源。

电池充电及外接电池连接方法

首次使用本产品前，请将电池充满电后再使用。

1. 电池充电方法

电源输入接口连接电源后，充电开始。

此时，充电 LED（红色）亮起。（见下图）

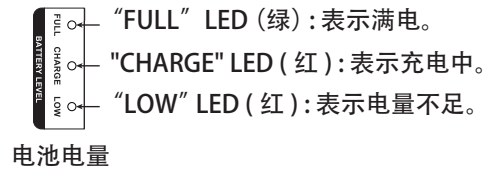
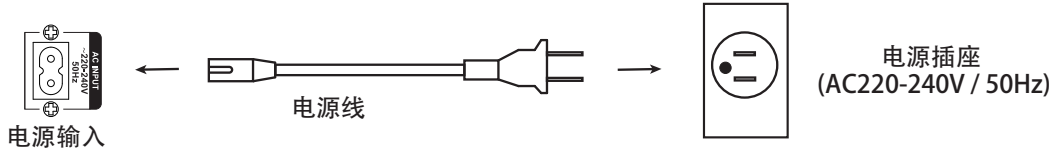

2. 外接电池连接方法

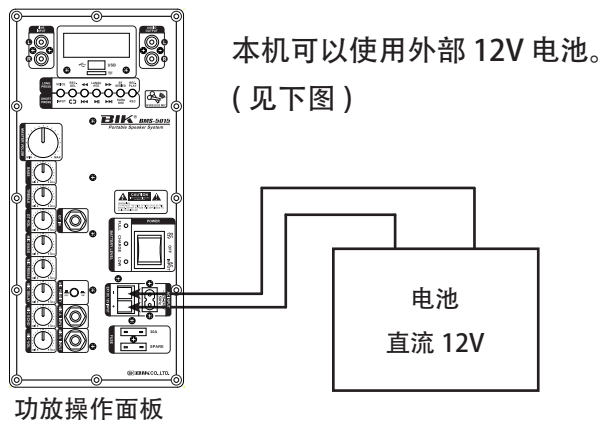

操作方法

1. 使用前一定先将轮子②1锁定后再使用。

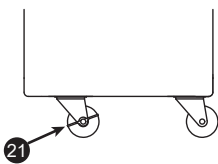

2. 用附带的电源线将“AC INPUT”⑱和“电源插座”连接。
3. 打开电源开关⑳。
4. 按⑤“INPUT”（输入信号）选择输入信号。
5. 旋转“主音量旋钮”⑥来调节音量。
6. 麦克风使用结束后，可以将其放在麦克风底座㉒里。

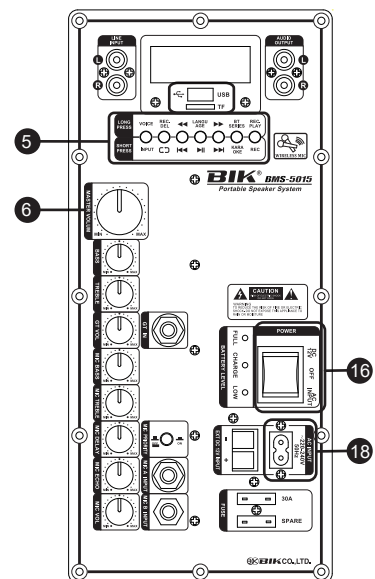
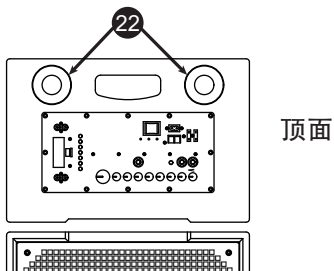

故障分析处理

如发现有故障请根据以下方法检查。偶尔会有因为操作错误而误认为是故障的现象。根据以下方法检查也不能解决的情况下，请直接联系贩卖店。

| 症状 | 原因 | 处理 |
|------------------|----------------------------------|-----------------------------|
| 不通电 | ● 没有插入电源或电池电量不足 | ● 插入电源线/充电 |
| 通电后有音乐信号输入但是没有声音 | ● 音量旋钮没有打开 ● 输入信号连接线不良或者没有连接好 | ● 调节适当的音量位置 ● 检查连接线，重新连接 |
| 出现杂音 | ● 电池电量过低 | ● 插入电源线/充电 |

产品规格

功能放大器部分

| | |
|----------|-----------------------------|
| 最大输出 | 220W / 4Ω |
| 频率特性 | 20Hz - 20kHz |
| 音乐输入灵敏度 | 200mV |
| 麦克风输入灵敏度 | 20mV |
| 吉他输入灵敏度 | 20mV |
| 前级输出 | 5V |
| 电池型号 | 6 - DZF - 20.2 (12V 20.2Ah) |

扬声器部分

| | |
|------|-----------|
| 低音单元 | 380mm 圆锥形 |
| 高音单元 | 号角形 |

无线麦克风

| | |
|--------|---|
| 电源工作电压 | DC3.7V - 4.2V (一节18650锂电池) |
| 工作电流 | > 80mA |
| 连续使用时间 | 约8 - 10小时 (根据电池容量来定) |
| 频率 | U段变频: 740.3 - 805.3MHz |
| 通道 | MIC A: 740.3 - 755.3MHz (01 - 50CH) MIC B: 790.3 - 805.3MHz (51 - 100CH) |

| | |
|------|--------------|
| 动态范围 | > 105 dB |
| 频率响应 | 40Hz - 15kHz |
| 拾音器 | 动圈式 / 单指向性 |

电源及其他

| | |
|------------------|-------------------------------|
| 电源电压 | AC220 - 240V / 50Hz DC 12V |
| 电源功耗 | 60W |
| 外形尺寸 (长 x 宽 x 高) | 446 x 300 x 734mm |
| 净重 | 30.9Kg |

附属品

| | |
|--------------------|-------------------|
| 使用说明书 | 1个 |
| 电源适配器 | 1个 |
| 遥控器 | 1个 |
| 无线麦克风 | (MIC A, MIC B) 2个 |
| USB 数据线 | 2个 |
| 电池盒(MIC A, MIC B用) | 2个 |

● 为了改善产品而改变上述规格和外观时，本公司将不予另行通告。

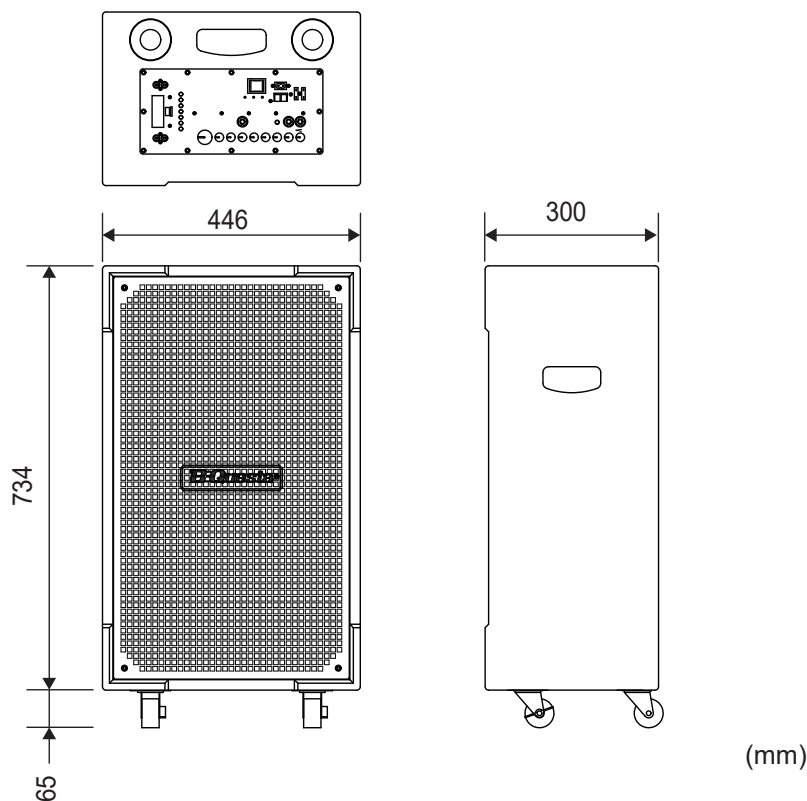



株式会社 ビーアイケー
〒343-0856 埼玉県越谷市谷中町3丁目17-1

BIK CO.,LTD.
3-17-1 YANAKA-CHO. KOSHIGAYA-SHI. SAITAMA-KEN. 343-0856 JAPAN
TEL. +81-48-969-6533 FAX. +81-48-969-6556
URL. <http://www.bik-audio.com> Email. best-sound@bik-coltd.jp