

OWNER'S MANUAL
使用说明书

Professional D-Class Power Amplifire
专业功率放大器

2 CH (2 声道)

AK-D1020
AK-D1820

4 CH (4 声道)

AK-D1040

2 CH (AK-D1020, AK-D1820)
2 声道

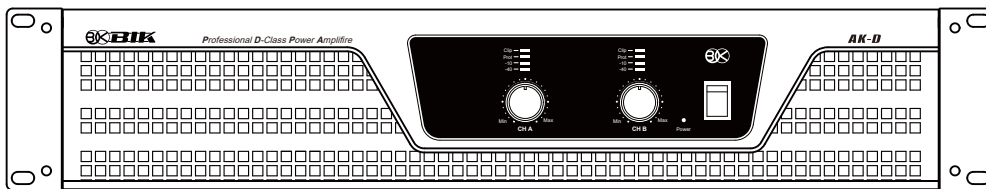

4 CH (AK-D1040)
4 声道

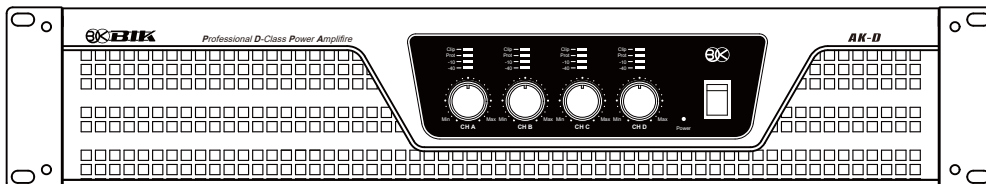



Thank you for purchasing our Professional D-Class Power Amplifire.
Please read the owner's manual thoroughly prior to use.
Please keep the manual for future reference.

感谢您购买本公司的专业功率放大器。
为了尽快的熟悉掌握本产品的各项功能，使用前请仔细阅读本说明书。
阅读后，请注意妥善保管。

CAUTION FOR SAFETY

This "Caution for safety" shows various kinds of pictures in order to be used safely and correctly and to prevent from damaging other people, and their property. Please read with full understanding, and carefulness.

 WARNING	This shows: Using this product with disregarding cautions might call for death or injury.
 CAUTION	This shows: Using this product with disregarding cautions might call for people to be harmed and goods to be damaged.

WARNING

- Making use of this product under the circumstances that a smoke, an abnormal smell, an irregular sound coming out, it may cause a fire and an electric shock. In this case, switch off the product, and take AC plug out of the outlet right away. Bring it to the shop for repair.
- In case when water or foreign substances get into product, switch off right away, and take AC plug out of outlet, and consult with the repair shop, otherwise, it may cause a fire or an electric shock.
- Re-assembling this product is highly prohibited, otherwise, it may cause a fire or an electric shock.
- Do not take the cover out, otherwise, it may cause an electric shock. Inspection, repair should be done in the repair shop.
- This product can no way be used in the bathroom, otherwise, it may cause a fire, or an electric shock.
- Pay attention not for water to go into or get wet, or it may cause a fire or get an electric shock.
- This product can be used only with AC220V-240V, otherwise it may cause a fire or get an electric shock.
- This product is not designed for built-in installation : do not place the product in an enclosed place such as a bookcase or rack.
- Be careful for AC plug, or outlet not to get dust or to get wet, or it may cause a fire.

CAUTION

- When this product is not used for a longer period, power supply plug should be taken out of outlet.
- In case the thunder is generated near-by, take power supply plug out of outlet right away, or it may cause a fire or an electric shock.
- If this product needs to be moved, switch off first, and then take power supply plug out, or it may damage cord, and may cause a fire or an electric shock.
- Do not put this product near cooking counter or damp supply outlet, or it may cause a fire or an electric shock.
- Do not put this product on unstable desk, it may damage or injury when dropped.
- Do not leave this product for a longer period such as in the cars where all windows are shut, or place where direct sunshine hits, or it may damage each part of this product, and may cause a fire.

FUNCTION AND NAME

Front Panel

2 Channel (AK-D1020, AK-D1820)

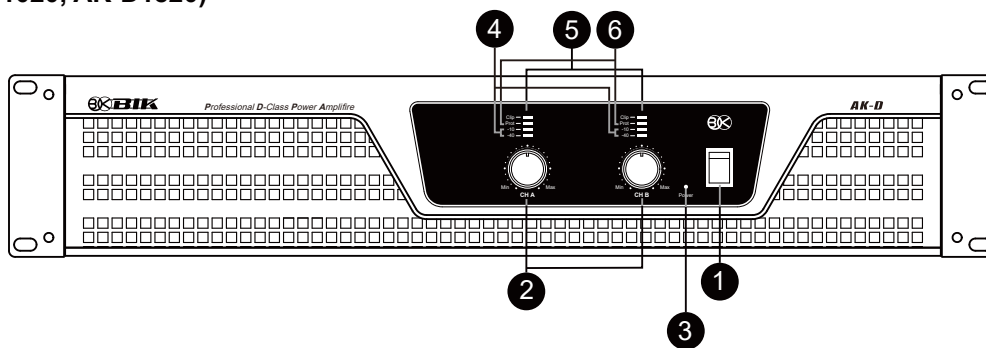

- | | |
|---|--|
| 1 POWER SWITCH
SWITCH For On And Off. | 4 SIGNAL INDICATOR |
| 2 VOLUME
CH-A, CH-B. | 5 CLIP INDICATOR |
| 3 POWER INDICATOR | 6 PROTECTION INDICATOR
An LED indicates at the time of operating protection. |

4 Channel (AK-D1040)

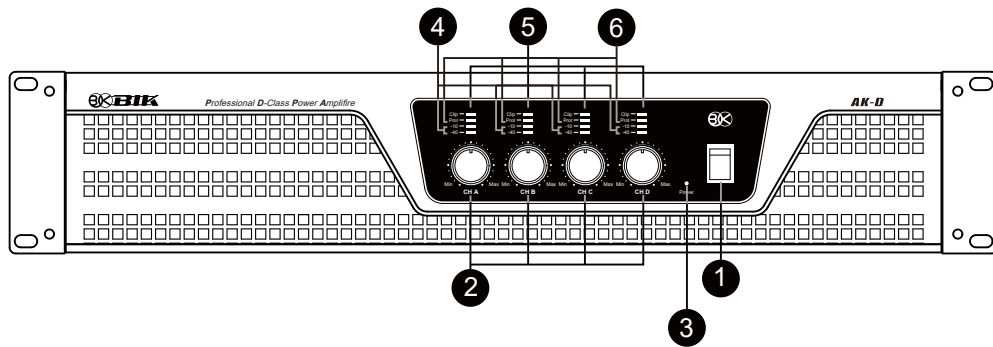

- 1 POWER SWITCH**
SWITCH For On And Off.
- 2 VOLUME**
CH-A, CH-B, CH-C, CN-D.
- 3 POWER INDICATOR**
- 4 SIGNAL INDICATOR**
- 5 CLIP INDICATOR**
- 6 PROTECTION INDICATOR**
An LED indicates at the time of operating protection.

Rear Panel

2 Channel (AK-D1020, AK-D1820)

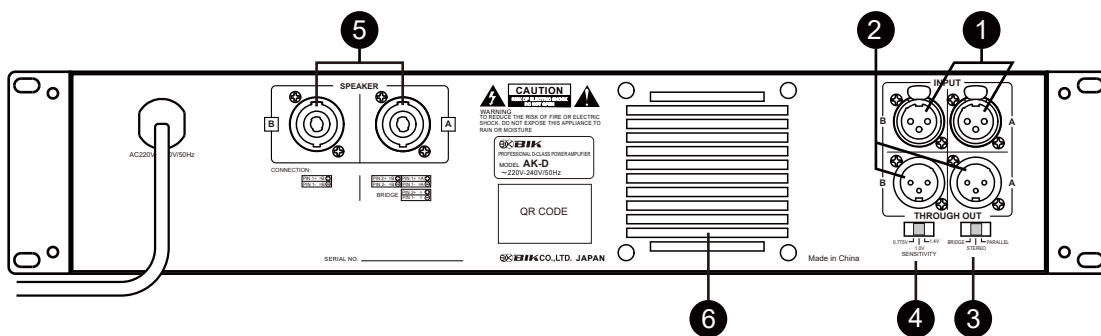

- 1 INPUT TERMINAL A/B XLR (CANON TYPE)**
- 2 THROUGH OUTPUT TERMINAL A/B (CANON TYPE)**
To be connected to another amplifier.
- 3 MODE SLECTOR SWITCH**
PARALLEL: (A+B) Monoral.
STEREO: (A), (B) Stereo.
BRIDGE: (A), (B) Bridge connection.
- 4 INPUT SENSITIVITY SELECTOR SWITCH**
Input sensitivity: 0.775V, 1V, 1.44V.
- 5 NL4 SpeakON OUTPUT TERMINAL A/B**
NL4 Speaker wire connection
CH A: 1+ = (A+), 1- =(A-)
2+ = (B+), 2- = (B-)
Bridge connection: 2+ = (+), 1- = (-)
CH B: 1+ = (B+), 1- =(B-)

How to connect to
NL4 "SpeakON" Terminal.

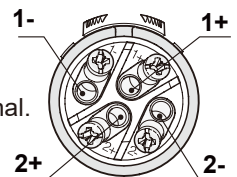

- 6 COOLING FAN**

4 Channel (AK-D1040)

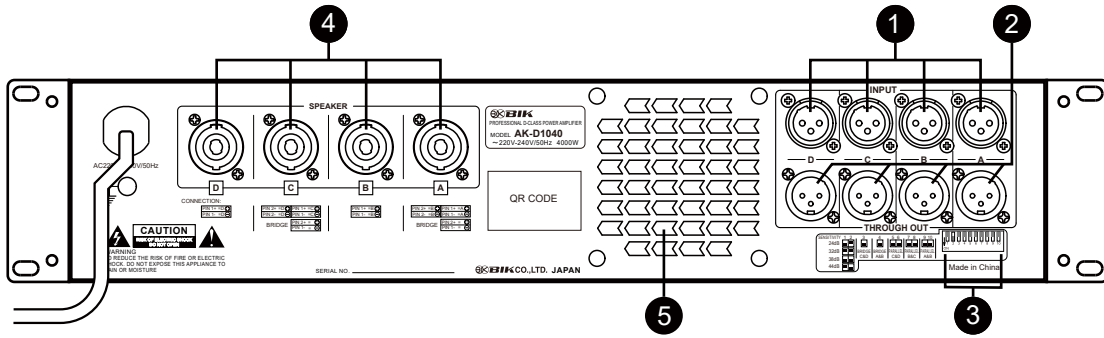

1 INPUT TERMINAL A/B/C/D XLR (CANON TYPE)

2 THROUGH OUTPUT TERMINAL A/B/C/D XLR (CANON TYPE)

To be connected to another amplifier.

3 MODE SLECTOR SWITCH

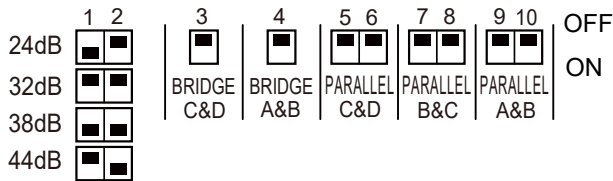

SENSITIVITY

※ **CAUTION**

When setting these switches, turn off the power switch of the amplifier.

4 NL4 SpeakON OUTPUT TERMINAL A/B/C/D

NL4 Speaker wire connection

CH A: 1+ = (A+), 1- = (A-)

2+ = (B+), 2- = (B-)

Bridge connection: 2+ = (+), 1- = (-)

CH B: 1+ = (B+), 1- = (B-)

CH C: 1+ = (C+), 1- = (C-)

2+ = (D+), 2- = (D-)

Bridge connection: 2+ = (+), 1- = (-)

CH D: 1+ = (D+), 1- = (D-)

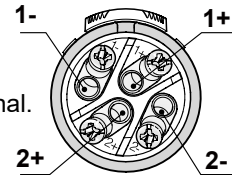

How to connect to NL4 "SpeakON" Terminal.

5 COOLING FAN

HOW TO CONNECT

2 Channel (AK-D1020, AK-D1820)

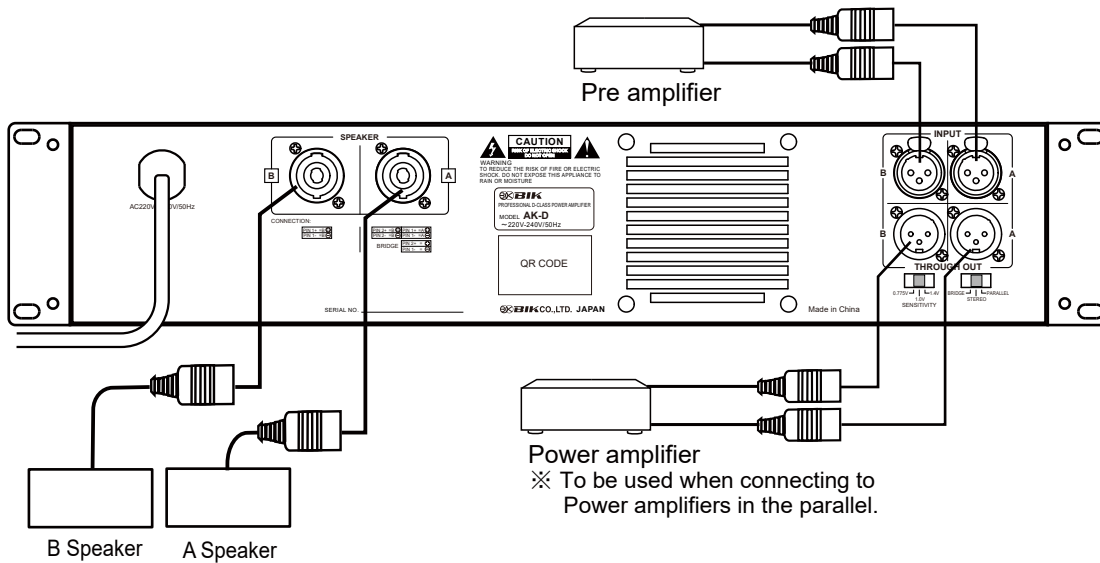

Power amplifier
 ※ To be used when connecting to Power amplifiers in the parallel.

4 Channel (AK-D1040)

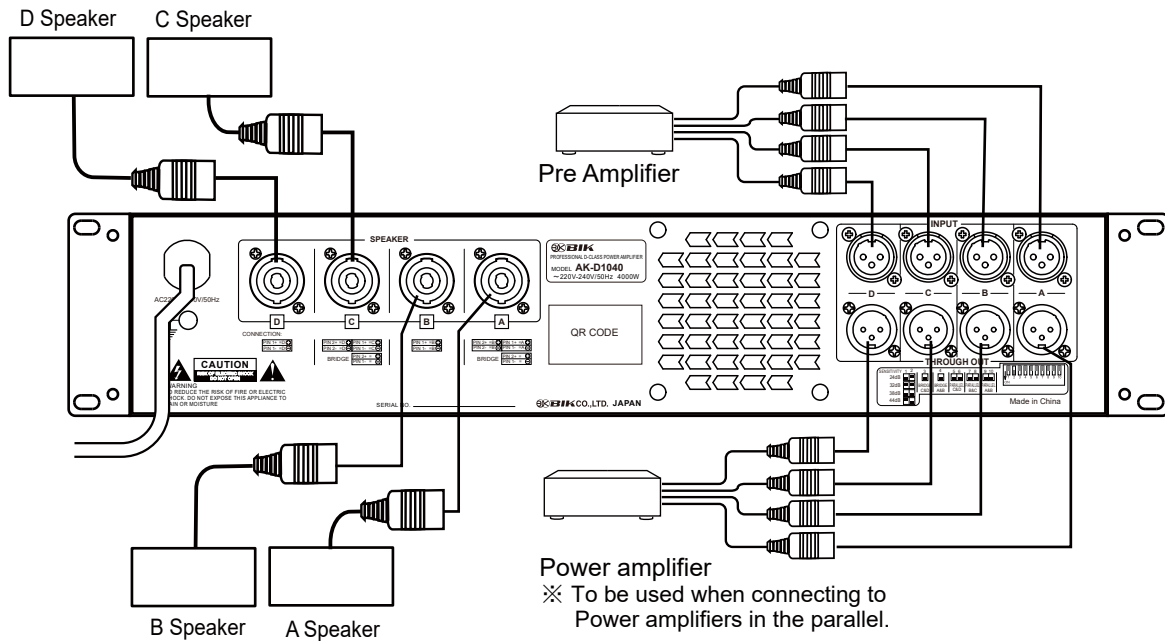

ANY TROUBLES?

Any troubles? please check the followings. Your careless mistakes may cause troubles. Consult with your dealers in case any troubles can not be solved after checking the followings.

Trouble	Cause	Remedy
Not power on	<ul style="list-style-type: none"> ● Not plugged in 	<ul style="list-style-type: none"> ● Plug in
No sound	<ul style="list-style-type: none"> ● Each volume is set at minimum position. ● Speaker wires not connected. ● Speaker wires damaged. ● Speaker wires in short circuit. ● Protection circuit is locked. 	<ul style="list-style-type: none"> ● Set volume at your required position. ● Connect speaker to speaker terminals. ● Repair wires. ● Repair "short circuit" ● Shut off Power switch and leave it for a while. And then Power switch "ON".
No sound even music starts, Nevertheless set volume is up.	<ul style="list-style-type: none"> ● Connected equipment volume is set at minimum. 	<ul style="list-style-type: none"> ● Set volume at your required position.
No sound from one Channel.	<ul style="list-style-type: none"> ● Input signal wires in defective or not connected correctly. ● Speaker wires in no sound channel is defective. 	<ul style="list-style-type: none"> ● Re-connect once again. ● Confirm speaker wires connection.

SPECIFICATIONS

2 Channel

	AK-D1020	AK-D1820
Max output power		
A, B (8 Ohms)	1000 W + 1000 W	1800 W + 1800 W
A, B (4 Ohms)	1500 W + 1500 W	2700 W + 2700 W
Bridged (8 Ohms)	3000 W	5400 W
Total Harmonic Distortion (THD)	0.15 % (max)	0.15 % (max)
Speaker Impedance	4 - 16 Ohms	4 - 16 Ohms
Input Sensitivity	0.775V/1V/1.44 V	0.775V/IV/1.44 V
Frequency response	20Hz - 20kHz	20Hz - 20kHz
Power Voltage	220 V - 240 V	220 V - 240 V
Power consumption	2000 W	4000 W
Dimensions (W X H X D)	484 mm (W) x 100 mm (H) x 410 mm (D)	
Weight	16.58 Kg	19.6 Kg
Accessories	Owner's manual	

4 Channel

	AK-D1040
Max output power	
A, B (8 Ohms)	1000 W + 1000 W
A, B (4 Ohms)	1500 W + 1500W
Bridge (A, B) (8 Ohms)	3000 W
C, D (8 Ohms)	1000 W + 1000W
C, D (4Ohms)	1500 w + 1500 W
Bridge (A, B) (8 Ohms)	3000 W
Total Harmonic Distortion (THD)	0.15 % (max)
Speaker Impedance	4 - 16 Ohms
Input Sensitivity	24dB, 32dB, 38dB,44dB
Frequency response	20Hz - 20kHz
Power Voltage	220 V - 240 V
Power consumption	4000 W
Dimensions (W X H X D)	484 mm (W) x 100 mm (H) x 410 mm (D)
Weight	17.92 Kg
Accessories	Owner's manual

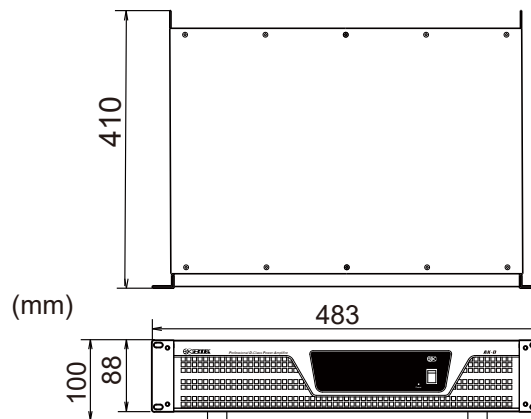

● Design and specifications subject to change without notice.



目录	安全注意事项	7	连接方法	9	产品规格	11
	各部分的功能及名称	7	故障分析处理	10		

安全注意事项

安全注意事项是为了安全正确使用本商品、防止给自己及他人带来财产损失。
以下用图标的形式加以注明。请仔细阅读本文。

 警告	警告 无视或误用会有造成人身事故的可能性。
 注意	注意 无视或误用会有造成人身伤残、或对财产损坏的可能性。

警告

- 在使用时、如果有冒烟、异味、异音等异常现象发生、为避免发生火灾、触电现象等、请立即切断本机电源、然后拔下AC电源插头。确认没有再冒烟后、到贩卖店进行修理。
- 在使用时如有水或异物等混入机体内、首先切断机体电源、然后拔下电源插头。请尽快与经销商联系、进行修理。
- 在未进行维修的状态下使用、会引起火灾、触电现象等问题。
- 请勿分解、改装本机器、会引起火灾、触电、故障等现象。绝对不可以打开本机器的外壳、会引起触电事故。内部的检查、修理等请委托经销商。
- 请勿在浴室内使用、会引起火灾、触电等现象。
- 请防止机器进水或使机器受潮、会引起火灾、触电等现象。
- 电源插头不要插入电压（AC220V - AC240V）以外的电源上。有造成火灾、触电的危险。
- 请不要用带有灰尘、或带有湿气的插头和插座、会引起火灾等现象。

注意

- 旅行等长时间不使用时、为了安全请务必拔下插头。
- 如近距离内有雷电现象时、请拔下电源插头，由于雷电原因，会引起火灾、触电、故障等现象。
- 移动时首先关闭电源开关、然后务必拔下电源插头。
- 请勿放置在灶台、加湿器及有油烟、雾气的地方。会引起火灾、触电等现象。
- 请勿放置在不安稳的桌上、或倾斜的地方。会容易掉落、翻倒而造成损坏、损伤等现象。
- 请勿放置在紧闭车窗的汽车内、或阳光直射及高温的地方。以免造成零部件的损坏、而引起火灾。

各部分的功能及名称

前面板

2 声道 (AK-D1020,AK-D1820)

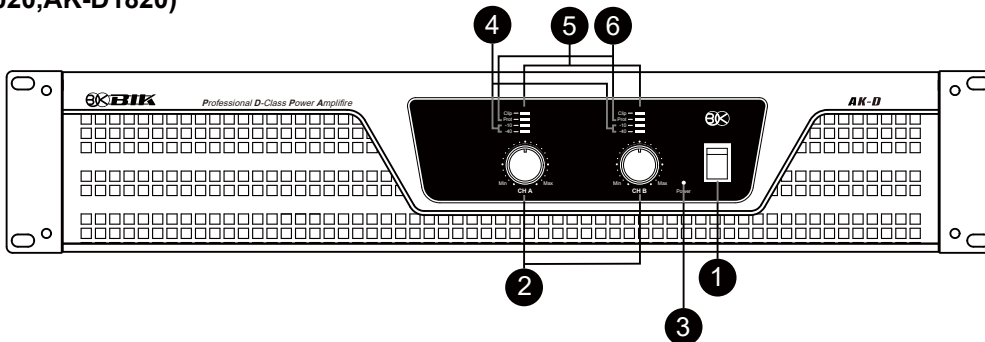

- | | |
|------------------------------|--------------------|
| 1 电源开关 | 4 信号指示灯 |
| 2 音量调节
CH-A, CH-B. | 5 CLIP峰值指示灯 |
| 3 电源指示灯 | 6 保护指示灯 |

4声道 (AK-D1040)

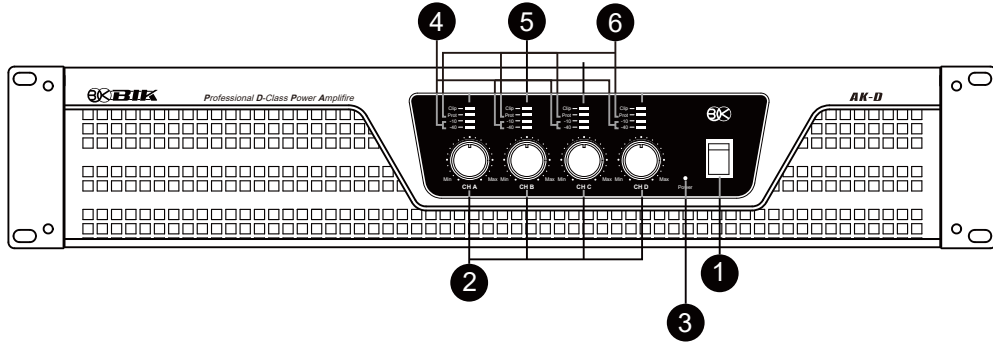

- ① 电源开关
- ④ 信号指示灯
- ② 音量调节
CH-A, CH-B, CH-C, CH-D
- ⑤ CLIP峰值指示灯
- ③ 电源指示灯
- ⑥ 保护指示灯

后背板

2声道 (AK-D1020, AK-D1820)

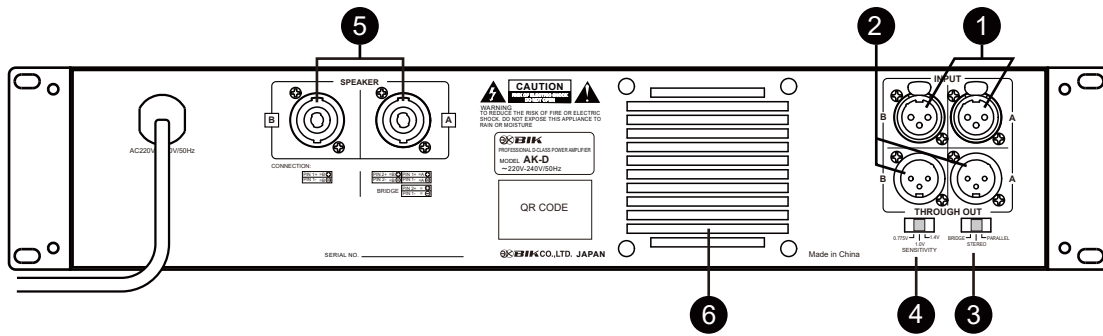

- ① 各声道 (A/B) 平衡信号输入接口 (卡侬母接口)
 - ② A-THROUGH, B-THROUGH 直通信号输出接口 (卡侬公接口)
该接口将功放A、B声道的输入信号不经过功率放大直接输出, 用于多台功放连接使用
 - ③ 输出模式选择 切换开关
- | | | | | | | | | | | | |
|------|---|---|--------|--------|----------|----------|----------|----------|----------|----|-----|
| 24dB | 1 | 2 | 3 | 4 | 5 | 6 | 7 | 8 | 9 | 10 | OFF |
| 32dB | ■ | ■ | ■ | ■ | ■ | ■ | ■ | ■ | ■ | ■ | ON |
| 38dB | ■ | ■ | BRIDGE | BRIDGE | PARALLEL | PARALLEL | PARALLEL | PARALLEL | PARALLEL | | |
| 44dB | ■ | ■ | C&D | A&B | C&D | B&C | A&B | | | | |

灵敏度

※ 注意

设置前关闭功放电源。

- ④ NL4 SpeakON 输出接口 A/B
NL4 扬声器接线。
CH A: 1+ = (A+), 1- = (A-)
2+ = (B+), 2- = (B-)
桥接: 2+ = (+), 1- = (-)
CH B: 1+ = (B+), 1- = (B-)
CH C: 1+ = (C+), 1- = (C-)
2+ = (D+), 2- = (D-)
桥接: 2+ = (+), 1- = (-)
CH D: 1+ = (D+), 1- = (D-)

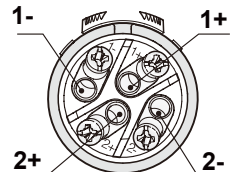

如何连接到
NL4 "SpeakON" 接口

- ⑤ 散热器

4 声道 (AK-D1040)

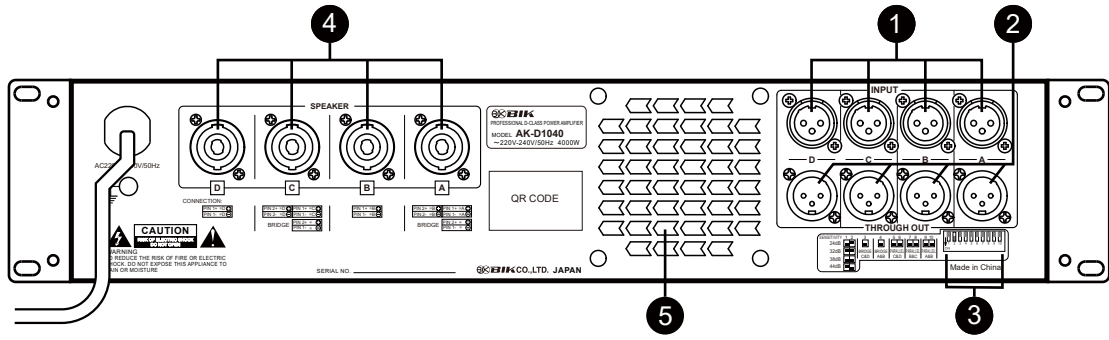

① 各声道 (A/B/C/D) 平衡信号输入接口 (卡侬母接口)

② THROUGH (A/B/C/D) 直通信号输出接口 (卡侬公接口)
该接口将功放A、B、C、D声道的输入信号不经过功率放大直接输出, 用于多台功放的连接使用

③ 模式选择 开关

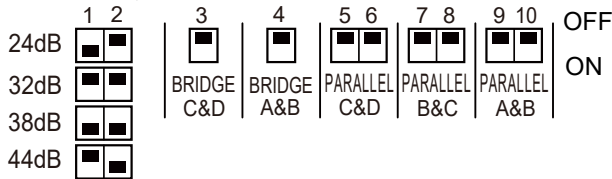

SENSITIVITY

※ 注意!
设置这些开关时,
关闭放大器的电源开关。

④ NL4 SpeakON 输出接口 A/B/C/D
NL4 扬声器接线。

声道 A: 1+ = (A+), 1- = (A-)
2+ = (B+), 2- = (B-)
Bridge connection: 2+ = (+), 1- = (-)
声道 B: 1+ = (B+), 1- = (B-)
声道 C: 1+ = (C+), 1- = (C-)
2+ = (D+), 2- = (D-)
桥接: 2+ = (+), 1- = (-)
声道 D: 1+ = (D+), 1- = (D-)

⑤ 散热器

如何连接到
NL4 "SpeakON" 接口

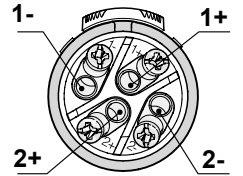

连接方法

2 声道 (AK-D1020, AK-D1820)

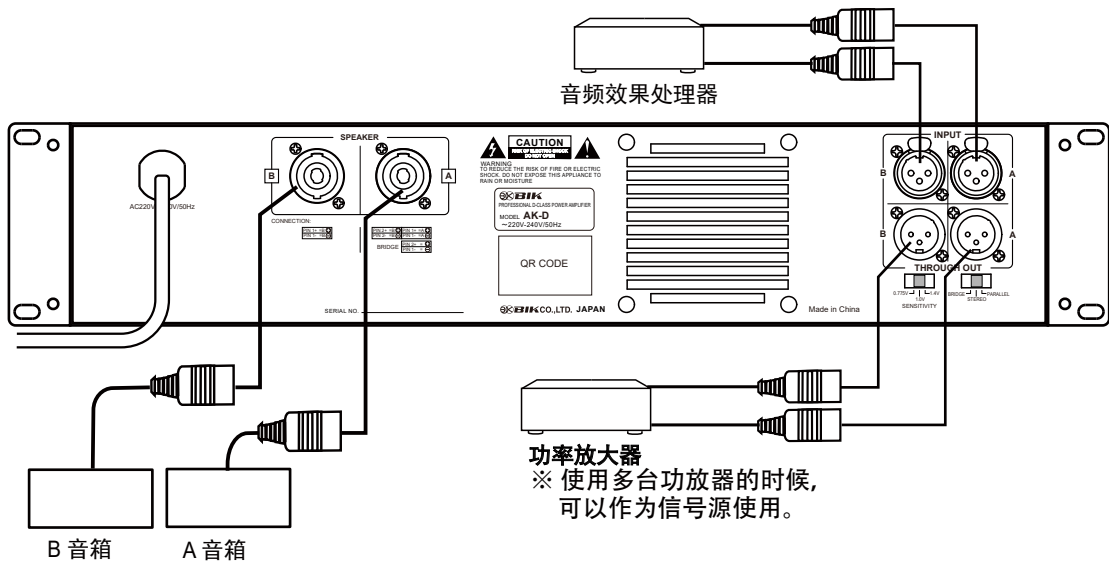

功率放大器
※ 使用多台功放器的时候,
可以作为信号源使用。

4 声道 (AK-D1040)

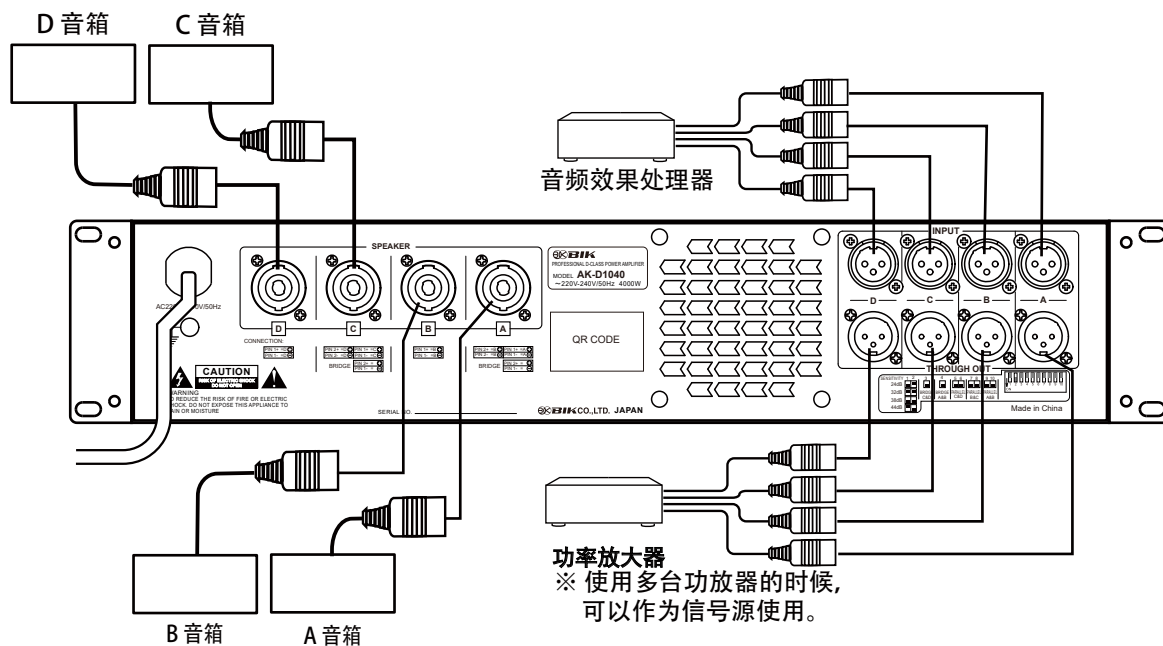

故障分析处理

如感觉有故障请根据以下方法检查。偶尔会有因为操作错误而误认为是故障的现象。
根据以下方法检查也不能解决的情况下，请直接联系代理经销商

故障症状	原因	解决方法
没有电源	● 电源线没有插好。	● 调节适当的音量
电源接通但是没有声音。	<ul style="list-style-type: none"> ● 音乐旋钮或麦克旋钮设定在最小的位置。 ● 音箱线没有连接好。 ● 音箱线有划伤。 ● 音箱线短路。 ● 超过流保护次数导致机器锁死。 	<ul style="list-style-type: none"> ● 请插好电源插头，将旋钮调整到适当位置。 ● 将音箱线连接到音箱端子 ● 修理更换音箱线 ● 修理短路位置 ● 关闭电源，重启
接通电源、接入音乐信号，但是没有声音。	● 音量旋钮设定在最小状态。	● 设定到适当音量的位置。
部分声道没有声音	<ul style="list-style-type: none"> ● 输入信号连接线，没有连接好。 ● 音箱连接线没有接好。 	<ul style="list-style-type: none"> ● 重新连接 ● 请重新确认音箱线的连接

产品规格

2 声道 (2CH)

	AK-D1020	AK-D1820
最大输出		
A, B (8 欧姆)	1000 W + 1000 W	1800 W + 1800 W
A, B (4 欧姆)	1500 W + 1500 W	2700 W + 2700 W
桥接 (8 欧姆)	3000 W	5400 W
失真 (THD)	0.15 % (max)	0.15 % (max)
音箱阻抗	4 - 16 欧姆	4 - 16 欧姆
输入灵敏度	0.775V/1V/1.44 V	0.775V/1V/1.44 V
频率响应范围	20Hz - 20kHz	20Hz - 20kHz
电源电压	220 V - 240 V	220 V - 240 V
电源功耗	2000 W	4000 W
外形尺寸 (长x高x宽)	484 mm (长) x 100 mm (高) x 410 mm (宽)	
净重	16.58 Kg	19.6 Kg
附件	说明书	

4声道 (4CH)

	AK-D1040
最大输出	
A, B (8 欧姆)	1000 W + 1000 W
A, B (4 欧姆)	1500 W + 1500W
桥接 A, B (8 欧姆)	3000 W
C, D (8 欧姆)	1000 W + 1000W
C, D (4 欧姆)	1500 w + 1500 W
桥接 C, D (8 欧姆)	3000 W
失真 (THD)	0.15 % (max)
音箱阻抗	4 - 16 欧姆
输入灵敏度	24dB, 32dB, 38dB, 44dB
频率响应范围	20Hz - 20kHz
电源电压	220 V - 240 V
电源功耗	4000 W
外形尺寸 (长x高x宽)	484 mm (长) x 100 mm (高) x 410 mm (宽)
净重	17.92 Kg
附件	说明书

- 因本机效果功能改善提升而变更规格等内容时不另行公告。

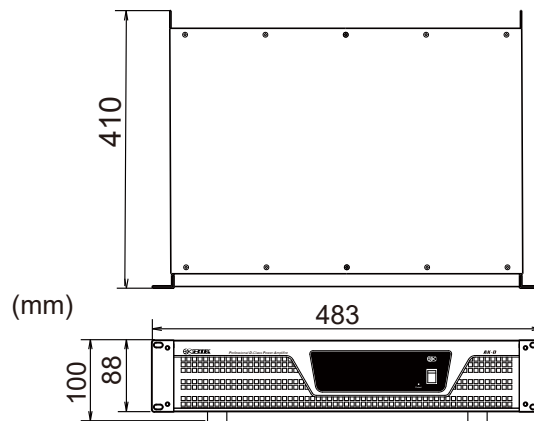



株式会社 ビーアイケー
〒343-0856 埼玉県越谷市谷中町3丁目17-1

BIK CO.,LTD.
3-17-1 YANAKA-CHO. KOSHIGAYA-SHI. SAITAMA-KEN. 343-0856 JAPAN
TEL. +81-48-969-6533 FAX. +81-48-969-6556
URL. <http://www.bik-audio.com> Email. best-sound@bik-coltd.jp